

Register your product and get support at
www.philips.com/welcome

BDP5005/F7 A

STOP! Thank you for choosing Philips.

Need help fast?

Read your Quick Start Guide and/or User Manual first for quick tips that make using your Philips product more enjoyable.

Register your product and get support at www.philips.com/welcome or call 1-866-309-0866 while with your product (and Model / Serial number)

ARRÊT! Philips vous remercie de votre confiance.

Besoin d'une aide rapide?

Le Guide rapide de début et Manuel de l'utilisateur regorgent d'astuces destinées à simplifier l'utilisation de votre produit Philips.

Enregistrez votre produit et accédez à l'assistance sur www.philips.com/welcome ou formez le 1-866-309-0866. Veillez à avoir votre produit à portée de main (et model / serial nombre)

ALTO! Gracias por escoger Philips

Necesita ayuda inmediata?

Lea primero la Guía rápida del comienzo o el Manual del usuario, en donde encontrará consejos que le ayudarán a disfrutar plenamente de su producto Philips.

Visite www.philips.com/welcome para registrar su producto y obtener información de contacto y asistencia. o llame al teléfono 1-866-309-0866 y tenga a mano el producto (y número de model / serial)

EN

BLU-RAY DISC PLAYER

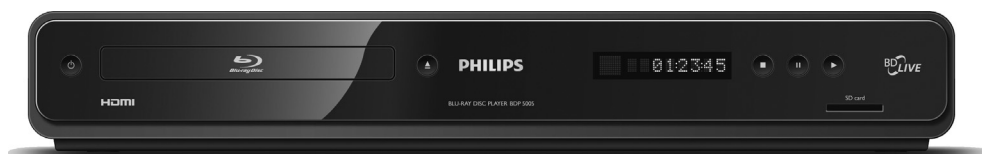

PHILIPS

PRECAUTIONS

Safety Instructions

The model and serial numbers of this unit may be found on the cabinet.
You should record and retain those numbers for future reference.

Model No.: _____

Serial No.: _____

WARNING: TO REDUCE THE RISK OF FIRE OR ELECTRIC SHOCK, DO NOT EXPOSE THIS APPARATUS TO RAIN OR MOISTURE. APPARATUS SHALL NOT BE EXPOSED TO DRIPPING OR SPLASHING AND NO OBJECTS FILLED WITH LIQUIDS, SUCH AS VASES, SHALL BE PLACED ON THE APPARATUS.



CAUTION
RISK OF ELECTRIC SHOCK
DO NOT OPEN



The lightning flash with arrowhead symbol, within an equilateral triangle, is intended to alert the user to the presence of uninsulated "dangerous voltage" within the product's enclosure that may be of sufficient magnitude to constitute a risk of electric shock to persons.



The exclamation point within an equilateral triangle is intended to alert the user to the presence of important operating and maintenance (servicing) instructions in the literature accompanying the appliance.

CAUTION:

TO REDUCE THE RISK OF ELECTRIC SHOCK, DO NOT REMOVE COVER (OR BACK). NO USER SERVICEABLE PARTS INSIDE. REFER SERVICING TO QUALIFIED SERVICE PERSONNEL.

The important note and rating are located on the rear or bottom of the cabinet.

IMPORTANT SAFETY INSTRUCTIONS

1. Read these instructions.
2. Keep these instructions.
3. Heed all warnings.
4. Follow all instructions.
5. Do not use this apparatus near water.
6. Clean only with dry cloth.
7. Do not block any ventilation openings. Install in accordance with the manufacturer's instructions.
8. Do not install near any heat sources such as radiators, heat registers, stoves, or other apparatus (including amplifiers) that produce heat.
9. Do not defeat the safety purpose of the polarized or grounding-type plug. A polarized plug has two blades with one wider than the other. A grounding type plug has two blades and a third grounding prong. The wide blade or the third prong are provided for your safety. If the provided plug does not fit into your outlet, consult an electrician for replacement of the obsolete outlet.
10. Protect the power cord from being walked on or pinched particularly at plugs, convenience receptacles, and the point where they exit from the apparatus.
11. Only use attachments/accessories specified by the manufacturer.
12. Use only with the cart, stand, tripod, bracket, or table specified by the manufacturer, or sold with the apparatus. When a cart is used, use caution when moving the cart/apparatus combination to avoid injury from tip-over. 
13. Unplug this apparatus during lightning storms or when unused for long periods of time.
14. Refer all servicing to qualified service personnel. Servicing is required when the apparatus has been damaged in any way, such as power-supply cord or plug is damaged, liquid has been spilled or objects have fallen into the apparatus, the apparatus has been exposed to rain or moisture, does not operate normally, or has been dropped.

FCC WARNING

This equipment may generate or use radio frequency energy. Changes or modifications to this equipment may cause harmful interference unless the modifications are expressly approved in the manual. The user could lose the authority to operate this equipment if an unauthorized change or modification is made.

RADIO-TV INTERFERENCE

This equipment has been tested and found to comply with the limits for a Class B digital device, pursuant to Part 15 of the FCC Rules. These limits are designed to provide reasonable protection against harmful interference in a residential installation. This equipment generates, uses, and can radiate radio frequency energy and, if not installed and used in accordance with the instructions, may cause harmful interference to radio communications. However, there is no guarantee that interference will not occur in a particular installation. If this equipment does cause harmful interference to radio or television reception, which can be determined by turning the equipment off and on, the user is encouraged to try to correct the interference by one or more of the following measures:

- 1) Reorient or relocate the receiving antenna.
- 2) Increase the separation between the equipment and receiver.
- 3) Connect the equipment into an outlet on a circuit different from that to which the receiver is connected.
- 4) Consult the dealer or an experienced radio/TV technician for help.

This Class B digital apparatus complies with Canadian ICES-003.

Disconnect the mains plug to shut off when find trouble or not in use. The mains plug shall remain readily operable.

PRECAUTIONS

CAUTION: Danger of explosion if battery is incorrectly replaced. Replace only with the same or equivalent type.
WARNING: Batteries (Battery pack or battery installed) shall not be exposed to excessive heat such as sunshine, fire, or the like.

LASER SAFETY

This apparatus employs a laser. Only a qualified service person should remove the cover or attempt to service this apparatus, due to possible eye injury.

CAUTION: Use of controls or adjustments or performance of procedures other than those specified herein may result in hazardous radiation exposure.

CAUTION: Visible and invisible laser radiation when open and inter lock defeated. Do not stare into beam.

LOCATION: Inside, near the deck mechanism.

IMPORTANT COPYRIGHT INFORMATION

Unauthorized copying, broadcasting, public performance and lending of discs are prohibited. This product incorporates copyright protection technology that is protected by U.S. patents and other intellectual property rights. Use of this copyright protection technology must be authorized by Macrovision, and is intended for home and other limited viewing uses only unless otherwise authorized by Macrovision. Reverse engineering or disassembly is prohibited.

Do not place the unit on the furniture that is capable of being tilted by a child and an adult leaning, pulling, standing or climbing on it. A falling unit can cause serious injury or even death.

To Avoid the Hazards of Electrical Shock and Fire

- Do not handle the power cord with wet hands.
- Do not pull on the power cord when disconnecting it from an AC outlet. Grasp it by the plug.
- Do not put your fingers or objects into the unit.

Location and Handling

- Do not install the unit in direct sunlight, near strong magnetic fields, or in a place subject to dust or strong vibration.
- Avoid a place with drastic temperature changes.
- Install the unit in a horizontal and stable position. Do not place anything directly on top or bottom of the unit. Depending on your external devices, noise or disturbance of the picture and/or sound may be generated if the unit is placed too close to them. In this case, please ensure enough space between the external devices and the unit.
- Depending on the environment, the temperature of this unit may increase slightly. This is not a malfunction.
- Be sure to remove the disc and unplug the AC power cord from the outlet before carrying the unit.

Dew Condensation Warning

- Dew condensation may form inside the unit in the following conditions. If so, do not use this unit at least for a few hours until its inside gets dry.
 - The unit is moved from a cold place to a warm place.
 - Under conditions of high humidity.
 - After heating a cold room.

Note about Recycling

- This unit's packaging materials are recyclable and can be reused. Please dispose of any materials in accordance with your local recycling regulations.
- Batteries should never be thrown away or incinerated but disposed of in accordance with your local regulations concerning chemical wastes.



Notice for Progressive Scan Output

- Consumers should note that not all high definition television sets are fully compatible with this product and may cause artifacts to be displayed in the picture. In case of picture problems with 525(480) progressive scan output, it is recommended that the user switch the connection to the 'standard definition' output. If there are questions regarding your TV set compatibility with this 525p(480p) BD/DVD player, please contact our customer service center.



Products that have earned ENERGY STAR® are designed to protect the environment through superior energy efficiency.

PRECAUTIONS

Maintenance

Servicing

- Please refer to relevant topics on “TROUBLESHOOTING” on page 45 before returning the product.
- If you need to call a customer service representative, please know the model number and serial number of your product before you call. This information is displayed on the back of the product. Also, please take a moment to identify the problem you are having, and be prepared to explain this to the representative. If you believe the representative will need to help you with operations, please stay near the product. Our representatives will be happy to assist you. For online reference, please visit our web site at <http://www.philips.com/welcome>

Cleaning the cabinet

- Wipe the front panel and other exterior surfaces of the unit with a soft, slightly damp cloth.
- Never use a solvent, thinner, benzene or alcohol to clean the unit. Do not spray insecticide liquid near the unit. Such chemicals may discolor the surface or damage the unit.

Cleaning discs

- When a disc becomes dirty, clean it with a cleaning cloth. Wipe the disc from the center to out. Do not wipe in a circular motion.
- Do not use solvents such as benzine, thinner, commercially available cleaners, detergent, abrasive cleaning agents or antistatic spray intended for analog records.

Cleaning the disc lens

- If this unit still does not perform properly although you refer to the relevant sections and to “TROUBLESHOOTING” in this user manual, the laser optical pickup unit may be dirty. Consult your dealer or an Authorized Service Center for inspection and cleaning of the laser optical pickup unit.

Disc handling

- Handle the discs so that fingerprints and dust do not adhere to the surfaces of the discs.
- Always store the disc in its protective case when it is not used.
- Note that discs with special shapes (heart-shaped discs, octagonal discs, etc.) cannot be played back on this unit. Do not attempt to play such discs, as they may damage the unit.

Supplied Accessories

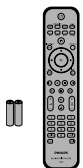

Remote Control
with Batteries
(AAAx2)

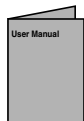

User Manual



Quick Start
Guide



Registration Card

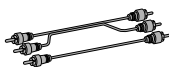

RCA Audio/
Video Cables

Trademark Information



Manufactured under license from Dolby Laboratories. “Dolby” and the double-D symbol are trademarks of Dolby Laboratories.



Manufactured under license under U.S. Patent #'s: 5,451,942; 5,956,674; 5,974,380; 5,978,762; 6,487,535 & other U.S. and worldwide patents issued & pending. DTS is a registered trademark and the DTS logos, Symbol, DTS-HD and DTS-HD Advanced Digital Out are trademarks of DTS, Inc. © 1996-2008 DTS, Inc. All Rights Reserved.



HDMI, the HDMI Logo, and High-Definition Multimedia Interface are trademarks or registered trademarks of HDMI Licensing LLC in the United States and other countries.



Java and all other Java trademarks and logos are trademarks or registered trademarks of Sun Microsystems, Inc. in the United States and/or other countries.

BONUS VIEW™ “BONUSVIEW” is trademark of Blu-ray Disc Association.



“BD-LIVE” logo is trademark of Blu-ray Disc Association.

“Blu-ray Disc” and  are trademarks.

 is a trademark of DVD Format/Logo Licensing Corporation.

CONTENTS

Introduction

Precautions	2
Safety Instructions	2
Contents	5
Features	6
Features	6
Product Info	6
Symbols Used in this User Manual	6
Functional Overview	7
Front Panel	7
Rear Panel	7
Remote Control	8
Front Panel Display	10
Guide to On-Screen Display	11

Connections

Connections	12
Connection to the TV	12
Connection to an Audio System	15
Network Connection with LAN	16

Basic Setup

Before You Start	17
Finding the Viewing Channel on Your TV	17

Playback

Information on Playback	18
Information on Playback	18
Guide to File List	20
How to Insert a Disc	20
Basic Playback	21
Playing Back a BD or a DVD	21
Playing Back an Audio CD or a Disc with JPEG Files	22
Reading the SD Memory Card	24
Using the Title / Disc Menu	24
Special Playback	25
Fast Forward / Fast Reverse	25
Slow Forward Playback	25
Step by Step Playback	25
Zoom	25
Repeat Playback	26
A-B Repeat	26
Slide Show	26
PiP (BONUSVIEW) Setting	26
Enjoying BD-Live Discs with Internet	27
Title/Chapter Search	27
Track Search	28
Time Search	28
Switching Subtitles	28
Switching Audio Soundtrack	29
Switching Camera Angles	29

Function Setup

List of settings	30
Setups	36
TV Shape	36
HDMI Video Resolution	36
HDMI Audio	37
Digital Out	38
Ratings Lock	39
EasyLink (HDMI CEC)	40
Network Connection	40
Software Upgrade	44
Reset to Factory Default	44

Others

Troubleshooting	45
Glossary	46
Specifications	48
ONE (1) YEAR LIMITED WARRANTY	49

FEATURES

Watch movies in the highest picture quality available for your HDTV. The BDP5005 Blu-ray Disc player offers full high-definition video playback up to 1080p resolution for an amazing viewing experience. A highly detailed picture and increased sharpness delivers a more true-to-life picture.

Features

Blu-ray Disc

You can enjoy Blu-ray Disc which is capable of storing five times more data than a conventional DVD.

BD Java

With some BDs which support Java applications, you can enjoy the interactive functions such as games or interactive menus.

Upscale DVD for enhanced picture quality

Your current DVD will look even better than before thanks to video upscaling. Upscaling will increase the resolution of standard definition DVD to high definition up to 1080p over an HDMI connection. The picture will be less jagged and more realistic for a near high definition experience.

Enjoy your content on different kinds of media

Full backwards compatibility with DVD, CD and SD Card ensures that you can continue to enjoy your current audio-video collection. Additionally, you can view JPEG digital pictures.

Listen to the rich multi-channel surround sound

Multi-channel surround sound, which realizes real-to-life sound and makes you feel that you are really there.

Intuitive user interface and remote control

The Philips logical user interface allows you to easily navigate through your content and settings, so you can quickly find what you are looking for.

Easy and simple connection to your HDTV via HDMI

Connect your BDP5005 to your HDTV with one single HDMI (High Definition Multimedia Interface) cable. Philips recommends HDMI1.3 (category 2) cable (also known as High Speed HDMI cable) for better compatibility. The high definition video output signal will be transferred to your HDTV without conversion to analog signals, so you will get an excellent picture and sound quality, completely free from noise. Thanks to other multiple outputs, you can also easily connect to your home theater system or amplifier.

About EasyLink (HDMI CEC) (Consumer Electronics Control)

EasyLink (HDMI CEC) allows you to operate the linked functions of this player with Philips brand TV with EasyLink feature.

Philips does not guarantee 100 % interoperability with other brands of HDMI CEC compliant devices.

PiP (BONUSVIEW)

Some BD-videos have the PiP function which enables you to display the secondary video in the primary video. You can call up the secondary video by pressing **[BONUSVIEW (PiP)]** whenever the scene contains the secondary video.

BD-Live

BD-Live (BD-ROM version 2 Profile 2.0) that allows interactive functions to be used when this unit is connected to the Internet in addition to the BONUSVIEW function. The various functions differ depending on the disc.

Pop-up menu

Some BD-videos have a pop-up menu which is a navigation menu that can be called up and be operated on the screen without interrupting the playback. You can call up the pop-up menu by pressing **[DISC MENU / POP-UP MENU]**. Contents in the pop-up menu vary depending on the disc.

HDMI Deep Color

Deep Color reduces the posterization effect of the playback image. Refer to "HDMI Deep Color" in the "LIST OF SETTINGS" on page 31.

HDMI 1080p/24 output (BD only)

This unit is equipped with the feature which can provide the smooth movement in the playback of film originated material with the frame rate of 24 frames per second with progressive. (Available only when the display device is connected by an HDMI cable.) Refer to "HDMI 1080p/24" in the "LIST OF SETTINGS" on page 31.

Playing back the contents in SD Memory Card





You can play back JPEGs stored in an SD Memory Card. You can store picture-in-picture commentary, subtitles or other extras for BD-ROM Ver. 2 (Profile 2.0/ Profile 1.1) files in an SD Memory Card and play back with the BD-video.

Product Info

"Product Info" screen provides you with the information on this unit's hardware and software version information. You can also download the latest firm ware from the web site which is displayed in the "Product Info" screen, and update the firm ware by yourself. To access "Product Info", select "Product Info" in the home menu.

Symbols Used in this User Manual

To specify for which media type each function is, we put the following symbols at the beginning of each item to operate.

Symbol	Description
	Description refers to BD-video
	Description refers to DVD-video
	Description refers to audio CD/DTS-CD
	Description refers to DVD-RW/-R, CD-RW/-R and SD Card with JPEG files

If you do not find any of the symbols listed above under the function heading, the operation is applicable to all media.

FUNCTIONAL OVERVIEW

Front Panel

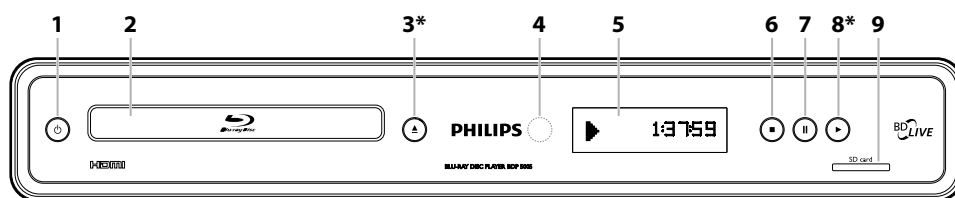

* The unit can also be turned on by pressing these buttons.

1. ⏻ (STANDBY-ON) button

- Press to turn on the unit, or to turn the unit into the standby mode. (To completely shut down the unit, you must unplug the AC power cord).

2. Disc tray

- Place a disc when opening the disc tray.

3. ▲ (OPEN/CLOSE) button*

- Press to open or close the disc tray.

4. Infrared sensor window

- Receive signals from your remote control so that you can control the unit from a distance.

5. Display

- Refer to "Front Panel Display" on page 10.

6. ■ (STOP) button

- Press to stop playback.

7. || (PAUSE) button

- Press to pause playback.

8. ▶ (PLAY) button*

- Press to start or resume playback.

9. SD card slot

- Insert an SD Memory Card and play back the contents in it.

Rear Panel

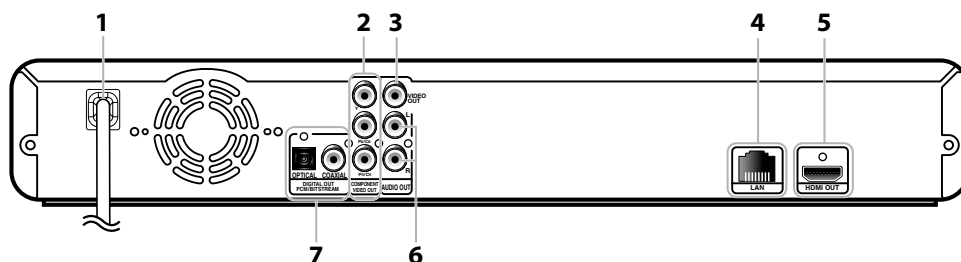

1. AC Power Cord

- Connect to a standard AC outlet to supply power to this unit.
- Unplug this cord from the AC outlet to completely shut down the unit.

2. COMPONENT VIDEO OUT jacks

- Use to connect a TV monitor with component video inputs with a component video cable.

3. VIDEO OUT jack

- Use to connect a TV monitor, an AV receiver / amplifier or other device with an RCA video cable.

4. LAN Terminal

- Use to connect a telecommunications equipment with LAN cable.

5. HDMI OUT jack

- Use to connect to a display with an HDMI compatible port with an HDMI cable.

6. AUDIO OUT jacks

- Use to connect a TV monitor, an AV receiver / amplifier or other device with an RCA audio cable.

7. DIGITAL OUT (OPTICAL/COAXIAL) jacks

- Use to connect an AV receiver / amplifier, Dolby Digital/DTS decoder or other device with a digital audio optical/coaxial input jack with a digital audio optical/coaxial cable.

Note

- Do not touch the inner pins of the jacks on the rear panel. Electrostatic discharge may cause permanent damage to the unit.
- This unit does not have the RF modulator.

FUNCTIONAL OVERVIEW

Remote Control

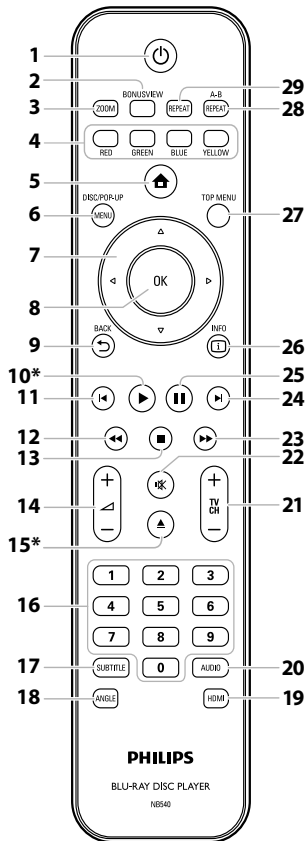

* The unit can also be turned on by pressing these buttons.

1. STANDBY-ON button

- Press to turn on the unit, or to turn the unit into the standby mode. (To completely shut down the unit, you must unplug the AC power cord)

2. BONUSVIEW (PiP) button

- Press to switch picture in picture feature on/off (only applicable to BD-video which supports the PiP (BONUSVIEW) function).

3. ZOOM button

- Press to enlarge the picture on the screen.

4. RED/GREEN/BLUE/YELLOW button

- Press to activate short cut keys on some BD-video function.
- When file list / setup list is shown, press to switch between pages.

5. HOME button

- Press to display the home menu.

6. DISC MENU / POP-UP MENU button

BD:

- Press to display the pop-up menu.

DVD:

- Press to display the disc menu.

7. Cursor / / / buttons

- Press to select items or settings.

8. OK button

- Press to confirm or select menu items.

9. BACK button

- Press to return to the previously displayed menu or screen function.

10. PLAY button*

- Press to start playback or resume playback.

11. PREV button

- During playback, press once to return to the beginning of the current title, chapter, track or file.
- During the JPEG playback, press to return to the previous file.
- During playback, press twice to return to the previous title, chapter, track or file.

12. REW button

- During playback, press to fast reverse the playback.

13. STOP button

- Press to stop playback.

14. VOL + / - button

- Press to adjust the TV volume (only applicable to the PHILIPS brand TV).

15. OPEN/CLOSE button*

- Press to open or close the disc tray.

16. Number buttons

- Press to select a chapter during playback.
- Press to enter values in the input field.

17. SUBTITLE button

- Press to select subtitles on a disc.

18. ANGLE button

- Press to select camera angles on a disc.
- Press to rotate a picture (JPEG).

19. HDMI button

- Press to set the HDMI output mode.

20. AUDIO button

- Press to select the audio channel (such as audio languages) on a disc.

21. TV CH + / - buttons

- Press to change the channel up and down (only applicable to the PHILIPS brand TV).

22. MUTE button

- Press to mute the TV volume (only applicable to the PHILIPS brand TV).

23. FFW button

- During playback, press to fast forward the playback.
- When playback is in pause, press to slow forward the playback.

24. NEXT button

- During playback, press to skip to the next chapter, track or file.

25. PAUSE button

- Press to pause playback.
- When playback is in pause mode, press repeatedly to forward the playback step by step.

26. INFO button

- Press to display the information display.

27. TOP MENU button

BD:

- Press to display the top menu.

DVD:

- Press to display the title menu.

28. REPEAT A-B button

- Press to play back a defined section between point A and B repeatedly.

29. REPEAT button

- Press to toggle between various repeat modes.

Installing the Batteries in the Remote Control

Install the batteries (AAAx2) matching the polarity indicated inside battery compartment of the remote control.

1) Open the cover.

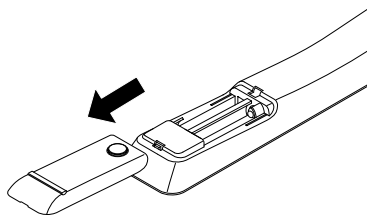

2) Insert batteries.

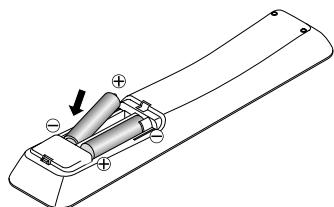

Make sure to match + and - on the batteries to the marks indicated in the battery compartment.

3) Close the cover.

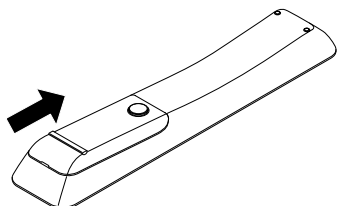

Note

Incorrect use of batteries can result in hazards such as leakage and bursting. Please observe the following:

- Do not mix new and old batteries together.
- Do not use different kinds of batteries together. Although they may look similar, different batteries may have different voltages.
- Make sure that the + and - ends of each battery match the indications in the battery compartment.
- Remove batteries from battery compartment that is not going to be used for a month or more.
- When disposing of used batteries, please comply with governmental regulations or environmental public instruction's rules that apply in your country or area.
- Do not recharge, short-circuit, heat, burn or disassemble batteries.

Using a Remote Control

Keep in mind the following when using the remote control:

- Make sure that there are no obstacles between the remote control and the infrared sensor window on the unit.
- Remote operation may become unreliable if strong sunlight or fluorescent light is shining on the infrared sensor window of the unit.
- Remote control for different devices can interfere with each other. Avoid using remote control for other device located close to the unit.
- Replace the batteries when you notice a fall off in the operating range of the remote control.
- The maximum operable ranges from the unit are as follows.
 - **Line of sight:**
approx. 23 feet (7 m)
 - **Either side of the center:**
approx. 16 feet (5 m) within 30°
 - **Above:**
approx. 16 feet (5 m) within 15°
 - **Below:**
approx. 10 feet (3 m) within 30°

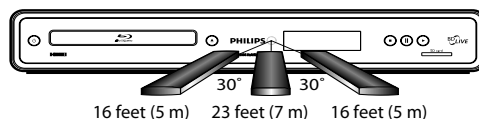

FUNCTIONAL OVERVIEW

Front Panel Display

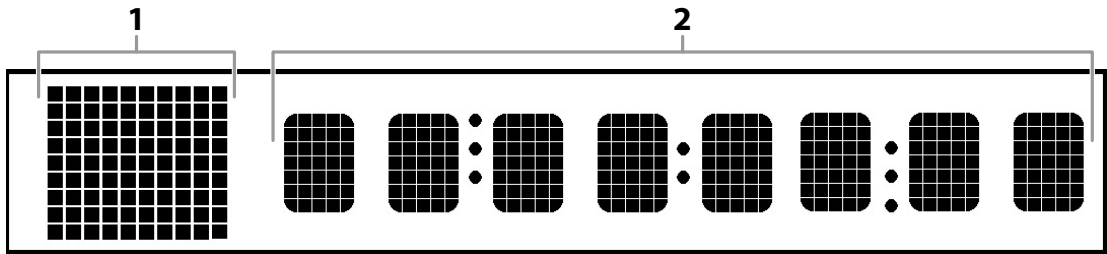

* Brightness of the display can be adjusted. Refer to "Front Panel Brightness" in "LIST OF SETTINGS" on page 33.

1. Displays playback status icon. Refer to the table below.
2. Displays various kinds of information such as title number, elapsed playing time, repeat type, menu type, etc.

Playback status icon		Mode
Disc	SD Memory Card	
		Playback is in progress
		Stop mode
		Pause mode
	—	Fast forward mode
	—	Fast reverse mode
	—	Slow forward mode
		Loading a media
		Appears while repeat function is set
		Appears while displaying the home menu

e.g.;



Title is being played back.
Indicating the current title number and the elapsed time.



Current chapter is in chapter repeat mode.



Loading a disc.

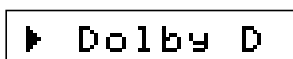

Dolby Digital audio is being played back.



DTS audio is being played back.

Guide to On-Screen Display

Home Menu

When you turn on the unit, home menu will appear automatically. Otherwise, press [HOME ▲].



- "Disc Tray"** : To access the track/file list or media filter screen
- "SD Card"** : To access the file list or media filter screen
- "Settings"** : To access the settings menus
- "Product Info"** : To access the product information

Menu Screen

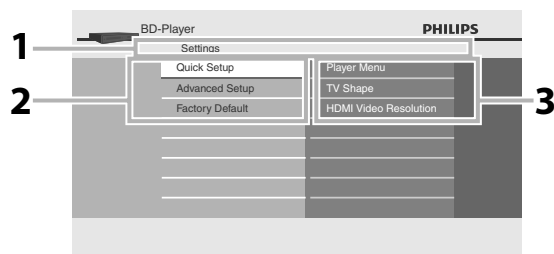

- 1. Directory**
Displays the current hierarchy.
- 2. Menus**
- 3. Options**
Displays options for the high-lighted item on the left whenever available.

CONNECTIONS

Connection to the TV

- 1 Choose the appropriate connection, then proceed to the corresponding instruction (A, B or C) on the next page.

Best (Supports up to 1080i^(*1), 1080p^(*2), 1080p/24 resolution.)

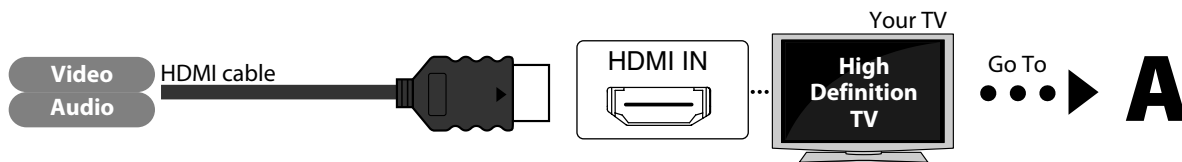

No analog audio connection required.

(*1) 1080i : Outputs the video data with frame rate of 30 frames per second.

(*2) 1080p : Outputs the video data with frame rate of 60 frames per second.

No supplied cables are used in this connection:

Please purchase the necessary cables at your local store.

High Speed HDMI Cable (also known as HDMI category 2 cable) is recommended for the better compatibility.

Better (Supports up to 1080i resolution.)

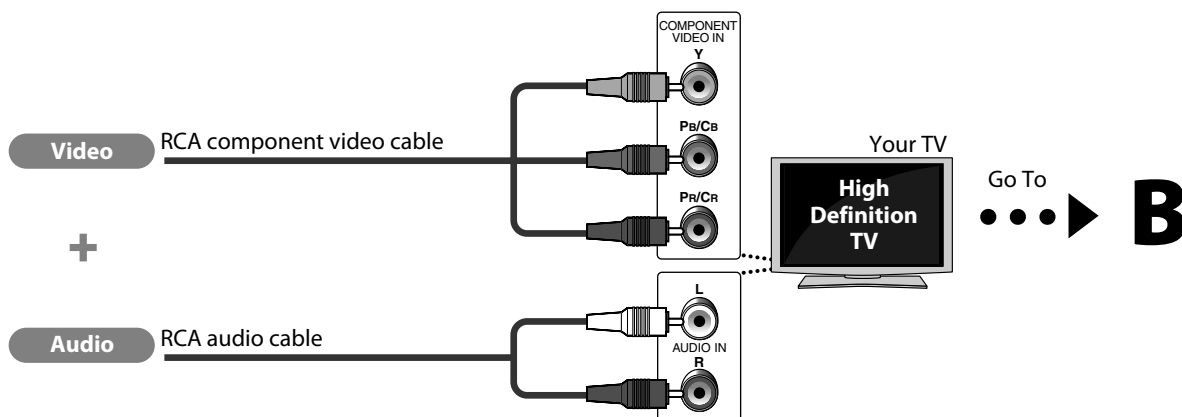

Supplied cables used in this connection are as follows:

- RCA audio cable (L/R) x 1

Please purchase the rest of the necessary cables at your local store.

Basic (Supports only 480i resolution.)

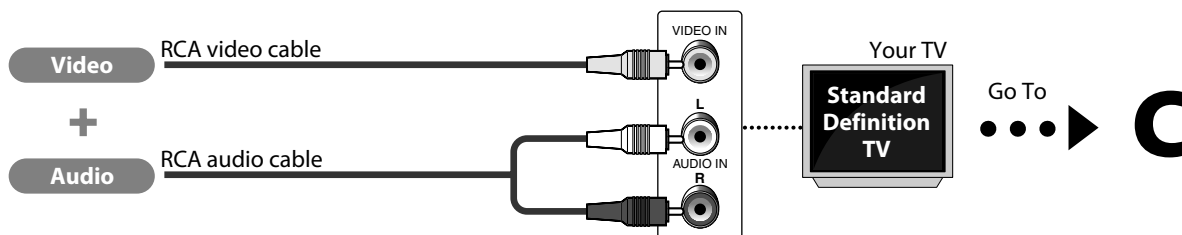

- Connect this unit directly to the TV. If the RCA audio / video cables are connected to a VCR, pictures may be distorted due to the copy right protection system.

Supplied cables used in this connection are as follows:

- RCA audio cable (L/R) x 1
- RCA video cable x 1

2 Connect the cables by following the descriptions below.

HDMI Video / Audio Connection

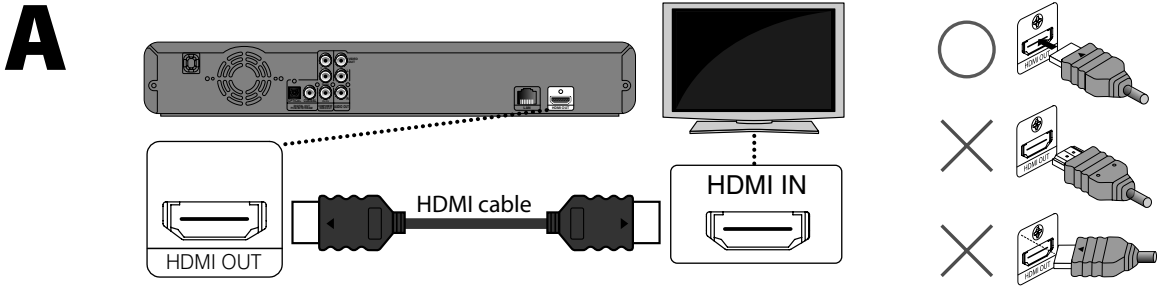

Component Video + Standard Audio Connection

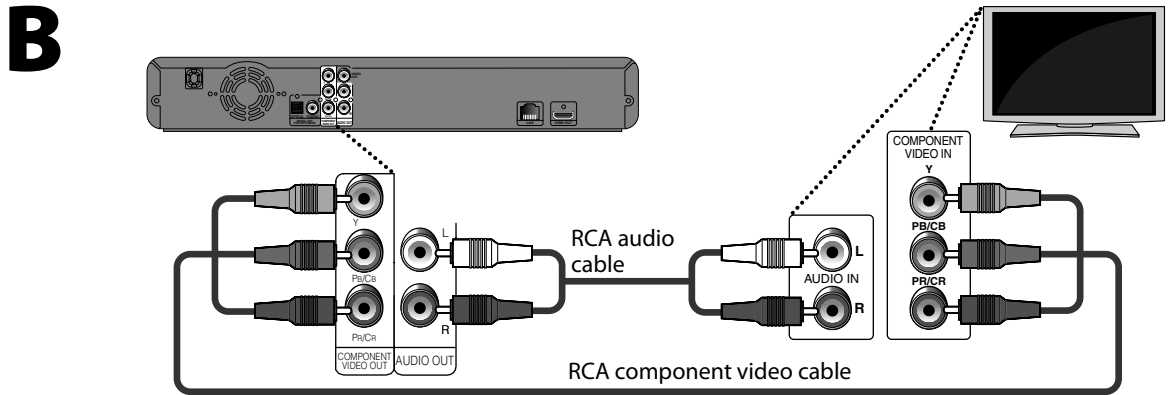

Standard Video + Standard Audio Connection

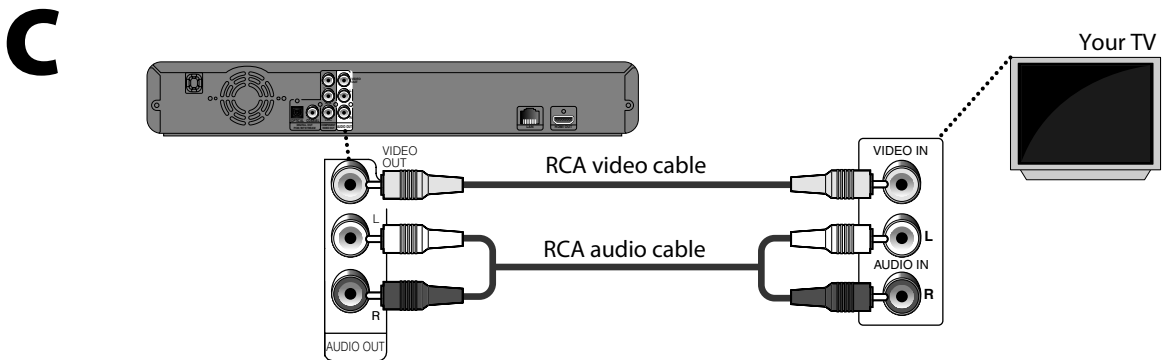

CONNECTIONS

HDMI Mode and Actual Output Signals

Press **[HDMI]** to change the resolution of the video signal being output from the HDMI OUT. The video resolution changes as follows every time **[HDMI]** is pressed. Or change the setting in the "HDMI Video Resolution" in the settings menu.

Font Panel Display	HDMI Video Resolution
480P	480 Progressive
Press [HDMI]	
720P	720 Progressive
Press [HDMI]	
1080i	1080 Interlaced
Press [HDMI]	
1080P	1080 Progressive
Press [HDMI]	

Copyright protection system

To play back the digital video images of a BD-video or DVD-video via an HDMI connection, it is necessary that both the player and the display device (or an AV receiver / amplifier) support a copyright protection system called HDCP (high-bandwidth digital content protection system). HDCP is copy protection technology that comprises data encryption and authentication of the connected AV device. This unit supports HDCP. Please read the operating instructions of your display device (or AV receiver / amplifier) for more information.

Note

- When using HDCP-incompatible display device, the picture will not be viewed properly.
- The audio signals from the HDMI jack (including the sampling frequency, the number of channels and bit length) may be limited by the device that is connected.
- Among the display device(s) that support HDMI, some do not support audio output (for example, projectors). In connections with device such as this unit, audio signals are not output from the HDMI output jack.
- When this unit's HDMI jack is connected to a DVI-D compatible display device(s) (HDCP compatible) with an HDMI-DVI converter cable, the signals are output in digital RGB.
- Pressing **[HDMI]** does not work when HDMI cable is not connected, or when no video signal is being output from the HDMI OUT jack.
- Pressing **[HDMI]** does not work during the playback of a BD-video or while displaying the settings menu.
- When you make a selection, the TV monitor temporarily goes blank and then comes back again. If it does not, press **[HDMI]** repeatedly to change the resolution or press and hold **[▶ (PLAY)]** on the front panel for 5 seconds to change the setting back to its default.

CONNECTIONS

Connection to an Audio System

- When you change the connections, all devices should be turned off.
- Refer to the manual accompanying external devices for more information.

2-Channel Analog Audio Connection

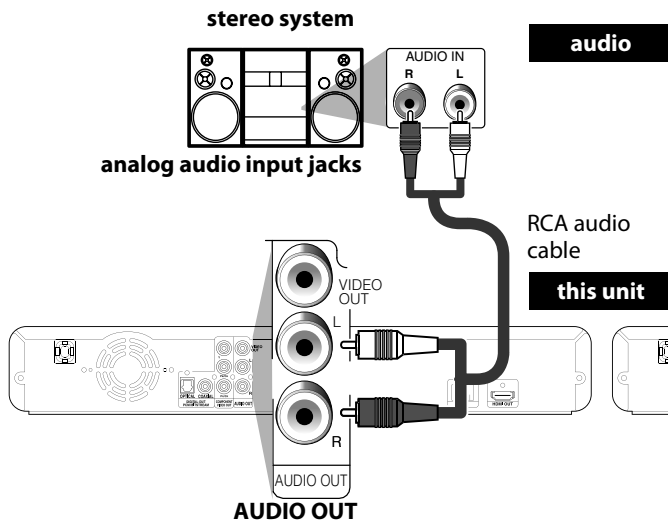

Digital Audio Connection

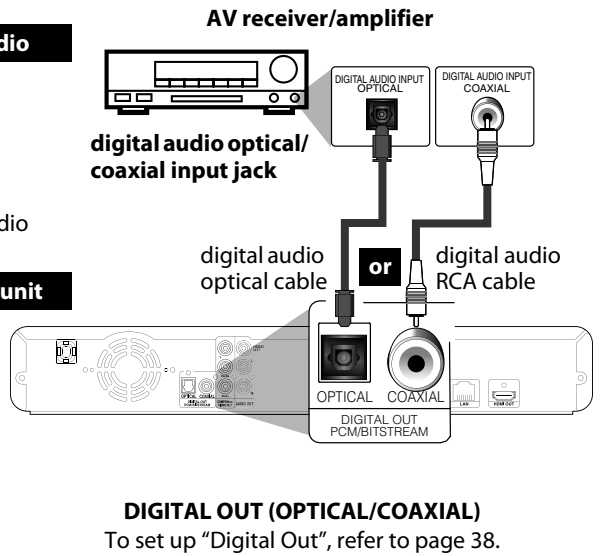

Optical cable

- Optical cable may be damaged when bent at sharp angles. Ensure cables are coiled in loops with a diameter of 6 inches (15 cm) or more when storing them.
- Use a cable which is 9.8 feet (3 m) or shorter.
- Insert cable plugs firmly into the connectors when making connections.
- If a plug has dust or is dirty, clean it with a soft cloth before inserting it into a connector.

Audio Output from Analog Out (2ch Jacks)

	"Blu-ray Disc Audio" setting →	"Primary Audio Only"	"Mix Audio Output"
Media ↓	Audio Source ↓		
BD-video	Dolby Digital	DownMix 2ch PCM	DownMix 2ch PCM
	Dolby Digital Plus	DownMix 2ch PCM ^{*1}	DownMix 2ch PCM ^{*1}
	Dolby TrueHD	DownMix 2ch PCM ^{*2}	DownMix 2ch PCM ^{*2}
	DTS	DownMix 2ch PCM	DownMix 2ch PCM
	DTS-HD	DownMix 2ch PCM ^{*3}	DownMix 2ch PCM ^{*3}
	LPCM	DownMix 2ch PCM	DownMix 2ch PCM
DVD-video	Dolby Digital	DownMix 2ch PCM	
	DTS	DownMix 2ch PCM	
	LPCM	2ch PCM	
Audio CD/ Windows Media™ Audio	PCM	2ch PCM	
DTS-CD	DTS	DownMix 2ch PCM	

*1) Only the independent substream is decoded.

*2) Only the Dolby Digital substream is decoded.

*3) Only the core substream is decoded.

CONNECTIONS

HDMI Audio Connection

AV receiver / amplifier with an HDMI input jack

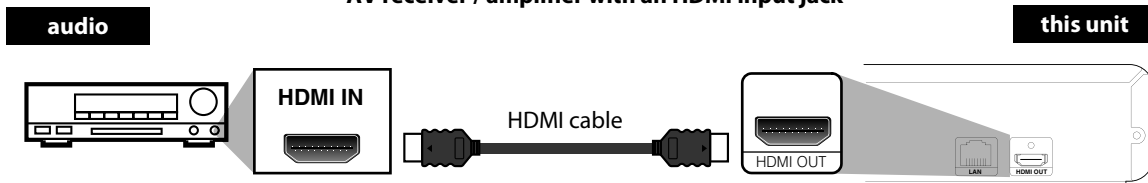

To set up "HDMI Audio" refer to page 37.

Supplied cables used in these connections are as follows:

- RCA audio cable (L/R) x 1

Please purchase the rest of the necessary cables at your local store.

Network Connection with LAN

- You can use a disc which offers BD-Live function by connecting the unit to the Internet.
(For BD-Live information, please refer to page 27)

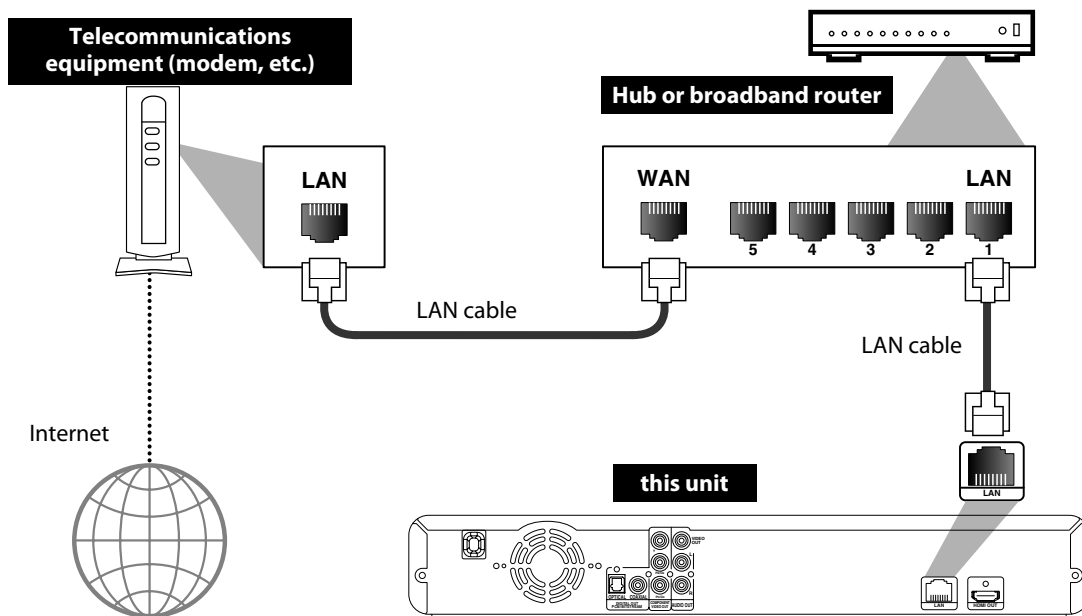

No supplied cables are used in this connection:

Please purchase the necessary cables at your local store.

Note

- After connecting to the Internet, set up necessary network settings.
- Do not insert any cable other than a LAN cable to the LAN terminal to avoid damaging the unit.
- If your telecommunications equipment (modem, etc.) does not have broadband router functions, connect a broadband router.
- If your telecommunications equipment (modem, etc.) has broadband router functions but there is no vacant port, use a hub.
- For a broadband router, use a router which supports 10BASE-T/100BASE-TX.
- Do not connect your PC directly to the LAN terminal of this unit.
- For the network setup, refer to "Network Connection" on page 40.

BEFORE YOU START

After you have completed all the connections, you must find the viewing channel (external input channel) on your TV.

Finding the Viewing Channel on Your TV

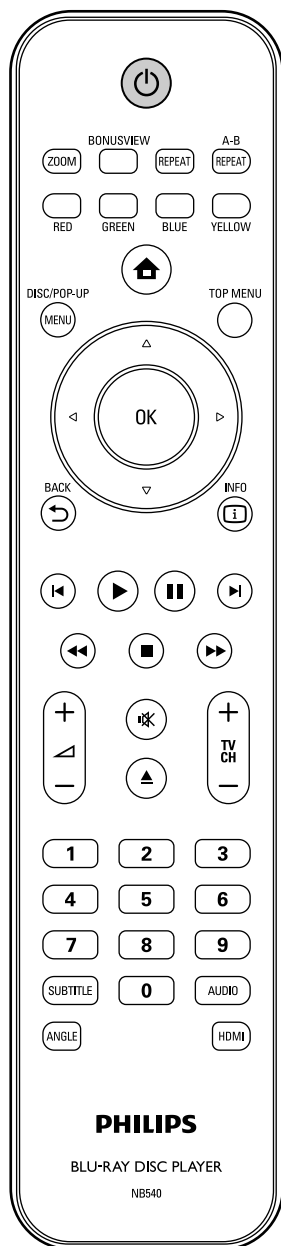

1 After you have made all the necessary connections, press [STANDBY-ON ] to turn on the unit.

2 Turn on your TV.

3 Press the button on the TV's remote control that accesses the external input channel. It may be labeled "SOURCE", "AV" or "SELECT" (refer to your TV's user manual). Or press "2" on the TV's remote control, then press channel down button repeatedly until you see the PHILIPS splash screen.

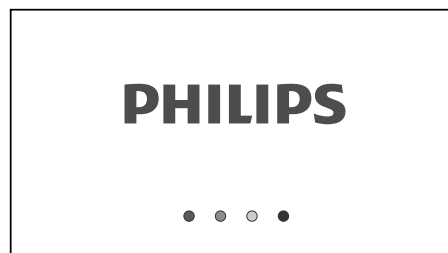

This is the correct viewing channel (external input channel).

- If a certain amount of time has passed since you turned on the unit, you may see the home menu instead of the PHILIPS splash screen.

Home menu:



INFORMATION ON PLAYBACK

Information on Playback

Before you start playing back a disc, read the following information.

Playable Discs and Files

This unit is compatible to play back the following discs / files. To play back a disc / file, make sure that it meets the requirements for region codes and color systems as described below. You can play back discs that have the following logos. Other disc types are not guaranteed to play back.

Playable discs	Logos
Blu-ray Disc - BD-video - BD-RE* (ver. 2.1) (Recorded in BDMV format) - BD-R* (ver. 1.1/1.2/1.3) (Recorded in BDMV format) (Unclosed discs may not be played back.)	
DVD-video	
DVD-RW (finalized video mode discs only)	
DVD-R (finalized video mode discs only)	
CD-DA (audio CD)	
CD-RW	
CD-R	
DTS-CD	-

(*) Due to the intentional progression of the Blu-ray Disc format by its standard setting authority, the company cannot guarantee or warrant the playability of future extensions of the Blu-ray Disc format with this product.

Playable files	Media
JPEG	DVD-RW/-R CD-RW/-R SD Memory Card (including SDHC) miniSD Card microSD Card

Readable cards	Playable files / data
SD Memory Card (8 MB - 2 GB)	JPEG, picture-in-picture commentary, subtitles or other extras for BD-ROM Ver. 2 (Profile 2.0/ Profile 1.1)
SDHC Memory Card (4 GB - 8 GB)	
miniSD Card (8 MB - 2 GB)	
microSD Card (8 MB - 2 GB)	

Note for SD Memory Cards

- This unit supports SD Memory Card with FAT12/ FAT16 file system, and SDHC Memory Card with FAT32 file system.
- This unit does not support NTFS file system.
- This unit may not read the SD Memory Cards formatted on a computer. If that is the case, please reformat the SD Memory Cards in this unit and try again.
- This unit does not support miniSDHC and microSDHC Memory Card.
- For miniSD Card and microSD Card, the adapter is necessary.

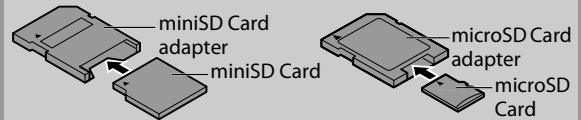

- Portions of this product are protected under copyright law and are provided under license by ARIS / SOLANA / 4C.
- Please keep the SD Memory Cards in their cases when you are not using them.
- Do not try to open or modify the card.
- Do not touch the terminal surface with your fingers or any metals.
- Do not attach additional labels or stickers to cards.
- Do not remove the label of the SD Memory Cards.
- This unit recognizes up to 8 characters of file name in the SD Memory Card. Characters after 8th will not be displayed.

INFORMATION ON PLAYBACK

Unplayable Discs and Files

The following discs will not be played back in this unit.

- CD-ROM
- DVD-RAM
- DVD-audio
- HD DVD
- unfinalized disc
- BD-RE (ver.1.0)
- BD-RE (ver.2.1) (Recorded in BDAV format)
- BD-R (ver.1.1/1.2/1.3) (Recorded in BDAV format)
- DVD / CD / SD Memory Card contains Windows Media™ Audio and DivX® files.
- Super Audio CD - Only the sound on the CD layer can be heard. The sound on the high-density Super Audio CD layer cannot be heard.
- Playability of dual discs are not guaranteed.
- CD-I (compact disc-interactive)
- VSD (video single disc)
- video CD
- SVCD

Color Systems

BD-video and DVD-video are recorded in different color systems throughout the world. The most common color system is NTSC (which is used primarily in the United States and Canada).

This unit employs NTSC color system, so the disc you play back must be recorded in the NTSC system. You cannot play back the disc recorded in other color systems.

Region Codes

This unit has been designed to play back BD-video with region "A" and DVD-video with region "1" or "ALL". You cannot play back BD-video or DVD-video that are labeled for other regions. Look for the symbols on the right on your BD-video or DVD-video.

If these region symbols do not appear on your BD-video or DVD-video, you cannot play back the disc in this unit. The letter or number inside the globe refers to region of the world. A BD-video or DVD-video labeled for a specific region can only be played back in the unit with the same region code.

BD-video



DVD-video



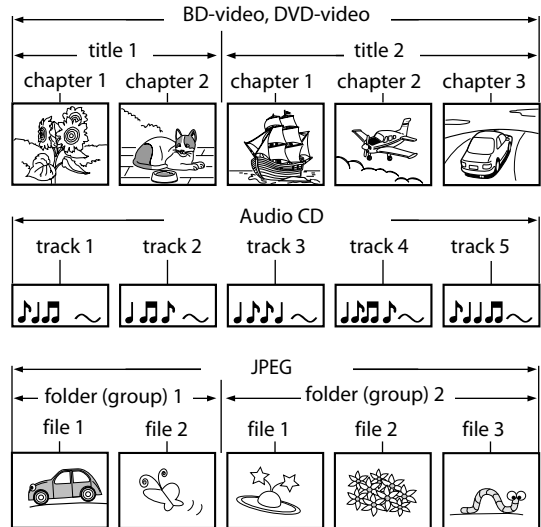

Hint for Disc Playback

The contents of disc are generally divided into sections or folders (groups of titles/files) as shown below.



Description for Icons

- [] : group (folder) icon
- [] : group (folder) return icon
- "Folders" refers to the groups of files.
- "Tracks" refers to the contents recorded on the audio CD.
- "Files" refers to the contents on a disc which are recorded in JPEG file format.

Note

- Unrecognizable characters will be replaced by "□".
- For DVD and SD Card, this unit can recognize up to 999 groups (folders), and 9999 tracks / files.
- For CD, this unit can recognize up to 255 groups (folders), and 999 tracks / files.

INFORMATION ON PLAYBACK

Guide to File List

Audio CD Track List

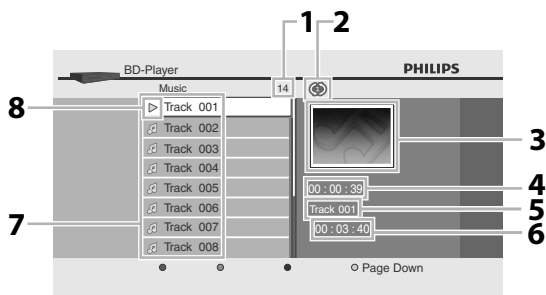

- 1) Total track number
- 2) Repeat status
- 3) Image
- 4) Elapsed playing time of the current track
- 5) Playing track number
- 6) Total time of the current track
- 7) Track list
- 8) Playback status

Picture Mode File List

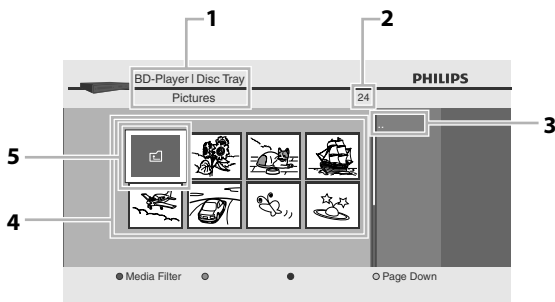

- 1) Directory
- 2) Number of contents in the current hierarchy
- 3) Current file name
- 4) Group (folder)/File list (thumbnails)
- 5) Root folder

How to Insert a Disc

- 1) Press [OPEN/CLOSE ▲] to open the disc tray.
- 2) Place the disc on the disc tray with its label side facing up.

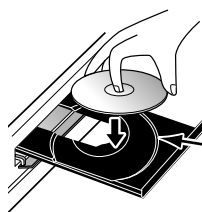

Align the disc to the disc tray guide.

* Make sure the disc is compatible with this unit. (Refer to page 18 for the list of compatible discs.)

- 3) Press [OPEN/CLOSE ▲] to close the disc tray.

It may take a while to load the disc.

To eject the disc:

Press [OPEN/CLOSE ▲] to open the disc tray.
Remove the disc.
Press [OPEN/CLOSE ▲] to close the disc tray.

BASIC PLAYBACK

Playing Back a BD or a DVD

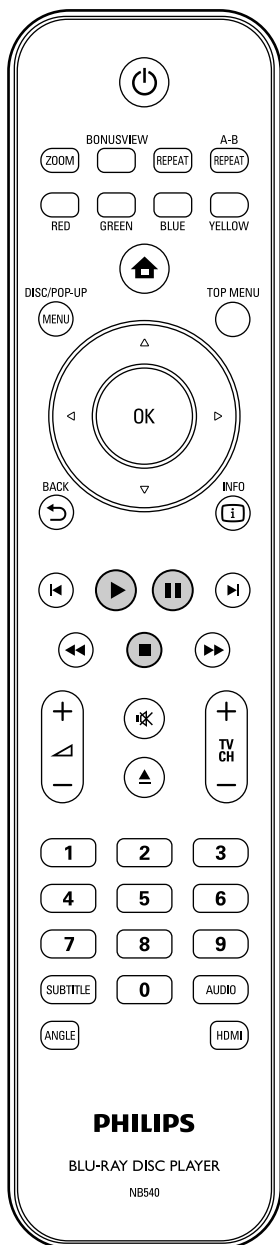

1 Insert a disc (refer to page 20 on how to insert a disc).

2 Playback may start automatically. If not, press **[PLAY ►]**. Some discs may show a title or a disc menu. In this case, refer to “Using the Title / Disc Menu” on page 24.

To pause playback:

Press **[PAUSE II]**.

To return to the normal playback:

Press **[PLAY ►]**.

To stop playback:

Press **[STOP ■]**.

Playback will be in Resume-On-Stop mode, and the home menu will appear.

<Resume-On-Stop mode>

When you press **[PLAY ►]** next time, the playback will start from the point where it has been stopped.

Note

- Playback will also stop and the home menu will appear when you press **[HOME ▲]**.
- For BD Java application, the Resume-On-Stop is not available.
- If you press **[OK]** instead of **[PLAY ►]**, playback can be started from the beginning of the disc even if it was in the Resume-On-Stop mode.
- You can also start from the beginning of the disc if you press **[PREV ◀]** while the resume message is displayed.
- The resume message can be removed by pressing **[BACK ↶]**.
- Resume-On-Stop mode remains in effect even after power is turned off, but will be cancelled once the disc is ejected.

BASIC PLAYBACK

Playing Back an Audio CD or a Disc with JPEG Files

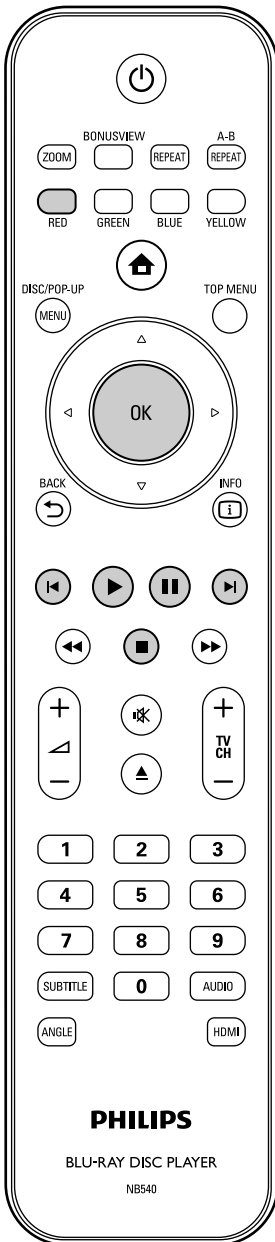

How to Navigate through the Track/File List

- Use [▲ / ▼] to move the highlight up and down in the list.
- To access the files in a group (folder), highlight the desired group (folder), then press [OK].
- Press [◀], or highlight [◀], then press [OK] to go back to the previous hierarchy.
- Press [◀] to go back to the previous screen.
- Press [BLUE] or [YELLOW] to change the page of the list.
- Press [RED] to go back to the media filter screen.
- Press [HOME ▲] to go back to the home menu.

Recommended specifications:

<JPEG>

Resolution

- Upper limit : 2,560 x 1,900 dots (sub sampling is 4:4:4)
: 5,120 x 3,840 dots (sub sampling is up to 4:2:2)
- Lower limit : 32 x 32 dots
- Maximum file size of a picture : 5 MB

Folder / File number limitations:

<DVD and SD Card>

- 999 folders (groups) and 9,999 files.

<CD>

- 255 folders (groups) and 999 tracks / files.

- 1 Insert a disc (refer to page 20 on how to insert a disc).**
 - Home menu appears automatically.

- 2 With “Disc Tray” selected, press [OK]. Media filter screen will appear.**
 - For audio CD, skip to step 4.

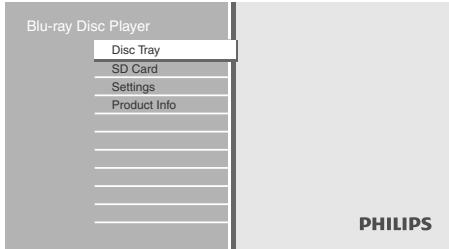

- 3 Select the type of the file you want to play back in the media filter screen. Then press [OK] to display the file list.**

- 4 Select a group (folder) or track/file you want to play back. Then press [PLAY ►] or [OK] to start playback.** Refer to “How to Navigate through the Track/File List” on page 22.

To skip to the next track/file:
Press [NEXT ►].

To skip to the previous track/file:
Press [PREV ◀].

To pause playback:
Press [PAUSE ||].

To return to the normal playback:
Press [PLAY ►].

To stop playback:
Press [STOP ■].

Playback will be in Resume-On-Stop mode.

<Resume-On-Stop mode for **audio CD**>

Playback will start from the point where it is stopped next time you press [PLAY ►].

If you press [OK] instead of [PLAY ►], playback will start from the beginning of the track instead of resuming from the stop point.

<Resume-On-Stop mode for **JPEG**>

Playback will start from the beginning of the current file next time you press [PLAY ►] or [OK].

To go back to the media filter screen :
Press [RED] in Resume-On-Stop mode.

Note

- Playback will also stop and the home menu will appear when you press [HOME ▲].

BASIC PLAYBACK

Reading the SD Memory Card

JPEG

You can play back the JPEG files in an SD Memory Card. With the SD Memory Card, you can also enjoy the following functions.

- Special additional contents for BD-ROM Profile 1 ver.1.1. (For more information about the special additional contents, refer to the instruction book that came with the disc.)
- BD-Live function (BD-ROM ver. 2 Profile 2.0). (For more information about BD-Live, refer to page 27.)

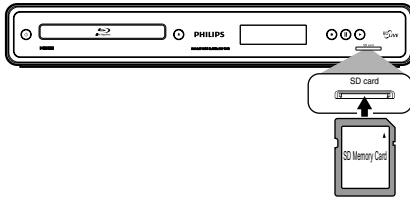

1 Insert an SD Card and then press [HOME ▲].

Home menu appears.

2 With "SD Card" selected, press [OK]. Media filter screen will appear.

3 Select the type of the file you want to play back in the media filter screen. Then press [OK] to display the file list.

4 Follow step 4 in "Playing Back an Audio CD or a Disc with JPEG Files" on page 22.

To remove the SD Memory Card:

In stop mode, gently push in the SD Memory Card, then pull it out slowly.

Note

- In the "SD Card" mode, the resume information will be cleared when;
 - [STOP ■] is pressed while in the Resume-On-Stop mode.
 - the SD Memory Card is removed.
 - the unit is turned into the standby mode.
- Do not remove the SD Memory Card or turn the unit to the standby mode while the contents of the card are in playback. It may result in malfunction or loss of the card's data.
- Do not delete the folders or files in the SD Memory Card with your computer. This unit may not read the SD Memory Cards formatted on a computer.

Using the Title / Disc Menu



Some BD-video or DVD-video may contain a title menu which describes the contents of the disc, or a disc menu which guides you through the available functions in the disc.

With such discs, a title menu or a disc menu may appear automatically when you insert the disc. Otherwise, press [TOP MENU] or [DISC MENU / POP-UP MENU] to call up the menu. Refer to the disc's manual on how to navigate through the menu.

Note

- Menus vary among discs. Refer to the information accompanying the disc for details.
- [TOP MENU] or [DISC MENU / POP-UP MENU] may not work with some discs.

SPECIAL PLAYBACK

Fast Forward / Fast Reverse



1) During playback, press [FFW ►►] repeatedly for fast forward.

During playback, press [REW ◀◀] repeatedly for fast reverse.

Every time you press [FFW ►►] or [REW ◀◀], the playback speed will change.

- For BD and DVD, speed changes in 5 different levels.
- For audio CD, speed changes in 3 different levels.

2) Press [PLAY ►] to return to the normal playback.

Slow Forward Playback



1) During playback, press [PAUSE II]. Then press [FFW ►►].

Every time you press [FFW ►►], the playback speed changes in 3 different levels.

2) Press [PLAY ►] to return to the normal playback.

Note

- Only slow forward is available.

Step by Step Playback



1) In pause mode, press [PAUSE II] repeatedly.

Every time you press [PAUSE II], playback will advance one step at a time.

2) Press [PLAY ►] to return to the normal playback.

Note

- Only step by step forward is available.

Zoom



During playback, you can zoom up the picture.

1) During playback, press [ZOOM] repeatedly.

Every time you press [ZOOM], zoom factor will change.

e.g.; DVD-video

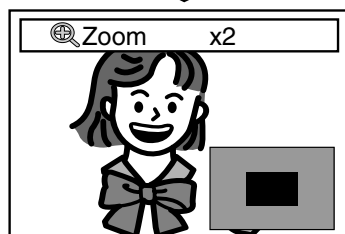
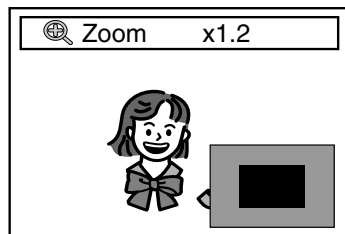

2) You can move over the zoomed picture using [▲ / ▼ / ◀ / ▶].

The gray box with an inner blue box displayed at the right bottom corner of the zoomed image is the position guide. The inner blue box indicates the zoomed area. (Not available for the JPEG playback.)

Note

- For JPEG files, slide show of the zoomed picture is not possible.
- For JPEG files, x4 zoom is not available.
- For some DVD, x4 zoom is not available.
- [ZOOM] does not work during the playback of the BD-video.
- [ZOOM] does not work while DVD menu is displayed.

SPECIAL PLAYBACK

Repeat Playback



Available repeat function varies depending on the discs.

- 1) **During playback, press [REPEAT] repeatedly to select the desired repeat function.**

REPEAT MODE	AVAILABLE MEDIA
Chapter Repeat The current chapter will be played back repeatedly.	BD-video/DVD-video
Title Repeat The current title will be played back repeatedly.	BD-video/DVD-video
Track Repeat The current track or file will be played back repeatedly.	Audio CD/DTS-CD/JPEG
All Repeat All tracks in the media will be played back repeatedly.	Audio CD/DTS-CD
Group Repeat The current group (folder) will be played back repeatedly.	JPEG
Random Repeat (Audio CD) Repeats the random playback.	Audio CD/DTS-CD
Random Repeat (JPEG) Repeats the random playback in a folder.	JPEG

Note

- The repeat setting will be cancelled when you stop playback.
- If you press [REPEAT A-B] when the repeat setting for BD, DVD or CD playback is set, the repeat setting will be cancelled.

A-B Repeat



You can play back the specific part (between point A and point B) repeatedly.

- 1) **During playback, press [REPEAT A-B] once at the point where you want to set point A.**
- 2) **During playback, press [REPEAT A-B] again at the point where you want to set point B.**

As soon as you set point B, the part between point A and point B will start to play repeatedly.

To cancel A-B repeat:

Press [REPEAT A-B] repeatedly until "Off" appears.

Note

- Point B should be set within the same title or track as point A.
- If you press [REPEAT A-B] when the repeat setting for BD, DVD or CD playback is set, the repeat setting will be cancelled.

Slide Show

JPEG

- 1) **Follow steps 1 to 3 in "Playing Back an Audio CD or a Disc with JPEG Files" on page 22.**

- 2) **Open the folder which contains the desired JPEG files.**

- 3) **Use [▲ / ▼ / ◀ / ▶] to select a desired track to be played back, then press [PLAY ▶] or [OK].**

- An image will be played back from the selected track and go to the next one in turn.

- 4) **Press [STOP ■] to stop playback.**

To return to the first item:

Press [TOP MENU].

To return to the track/file played last:

Press [DISC MENU / POP-UP MENU].

Note

- Large-size JPEG files take a few moments to be displayed.

PiP (BONUSVIEW) Setting



Some BD-videos have the PiP function which enables you to display the secondary video in the primary video. You can call up the secondary video by pressing [BONUSVIEW (PiP)] whenever the scene contains the secondary video.

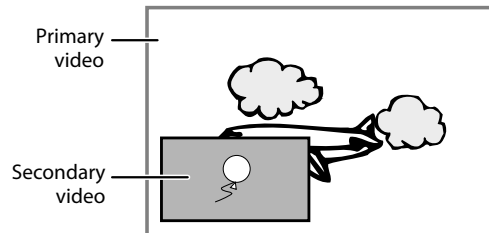

- 1) **During playback, press [BONUSVIEW (PiP)].**

PiP information will appear.

- 2) **Use [▲ / ▼] to select the secondary video you want to show.**

- The secondary video will be displayed with the secondary audio.
- You can use [▲ / ▼] to switch between "On" or "Off".

- 3) **Press [BACK ◀] to remove the PiP information.**

- On how to output the secondary audio, refer to "Switching Audio Soundtrack" on page 29 and "Blu-ray Disc Audio" on page 32.

Enjoying BD-Live Discs with Internet



You can enjoy the BD-Live functions which enable you to use the interactive functions when the unit is connected to the Internet. (For the Network connection, refer to page 40.)

Examples for BD-Live interactive functions :

- Download the additional contents such as the movie's trailer, subtitles and BD-Java, etc.
- While downloading, special video data may be played back.
- **Service and functions differ depending on the disc. Follow the instructions given by the disc when using the BD-Live function.**
- **You must insert an SD memory card when using the BD-Live function. (SD memory card of 1GB is recommended.)**
- **Do not remove the SD Memory Card when using the BD-Live function.**

Note

- You must connect the unit to the Internet and set up necessary settings in order to use the BD-Live function.
- For certain discs, setting for "BD-Live Setting" may need to be changed.
- Depending on your connection environment, it may take time to connect to the Internet or the Internet may not be connected.
- When BD-Live functions are used and the unit is connected to the Internet, you may be charged for this communication.
- Some discs with BD-Live function require memory when playing back the content. If you cannot play back a disc with BD-Live function, insert an SD card(1GB or more) which is formatted on this unit.

Note for AACs Online

- The player or disc IDs may be sent to the content provider when playing back a disc with BD-Live function.
- If you save your viewing history on the server by using these IDs, you will be introduced to other similar movies.
- You can save game score histories.

Title/Chapter Search



Using [PREV ◀] / [NEXT ▶]

- 1) **During playback, press [NEXT ▶] to skip the current title or chapter and move to the next.**

The title or chapter will move forward by one at a time.

- If there is no chapter in one title, the current title may be skipped.

To go back to the beginning of the current title or chapter, press [PREV ◀].

Press [PREV ◀] repeatedly to go to the previous title or chapter. The title or chapter may move backward one at a time.

Using [INFO ⓘ]

- 1) **During playback, press [INFO ⓘ].**

Disc	
Title	001/012
Chapter	001/023
Playing Time	00:01:31

- 2) **Use [▲ / ▼] to select "Title" or "Chapter".**

- 3) **Use [the Number buttons] or [◀ / ▶] to enter the title/chapter number.**

- 4) **Press [OK].**

Playback will start from the beginning of the title/ chapter.

- 5) **Press [INFO ⓘ] to remove the information display.**

Using [the Number buttons] (Direct Search)

Title Search

- 1) **In stop mode, enter the title number you want to search using [the Number buttons].**

Playback of the title will start in a few seconds.

Chapter Search

- 1) **During playback of a title, enter the chapter number you want to search using [the Number buttons].**

Playback of the chapter will start in a few seconds.

Note

- As for the BD-video, how it performs will be strongly determined by the disc, and may not perform as described.

SPECIAL PLAYBACK

Track Search



Using [PREV ◀] / [NEXT ▶]

- 1) During playback, press [NEXT ▶] to skip the current track or file and move to the next.

The track/file will move forward one at a time. To go back to the beginning of the current track/file press [PREV ◀].

Press it repeatedly to go to the previous track/file. The track/file will move backward one at a time.

Time Search



- 1) During playback, press [INFO ⓘ].

Disc	
Title	001/012
Chapter	001/023
Playing Time	00:01:31

- 2) Use [▲ / ▼] to select "Playing Time".
- 3) Use [the Number buttons] to enter the time count you want to jump to.

e.g.;

Entering 1 hour 45 minutes and 15 seconds.

Press

- 4) Press [OK].
Playback will start from the desired time count.
- 5) Press [INFO ⓘ] to remove the information display.

Switching Subtitles

Some BD and DVD may have subtitles in 1 or more languages. For commercially available discs, the supported languages can be found on the disc case. Follow the steps below to switch the subtitle languages during playback.



- 1) During playback, press [SUBTITLE] repeatedly to display "Primary", "Secondary" or "Subtitle Style".

"Primary" : Sets the subtitle for the primary video.

"Secondary" : Sets the subtitle for the secondary video.

"Subtitle Style" : Sets style of the subtitle.

- 2) Use [▲ / ▼] to select your desired subtitle or style.

Primary 1 English

- Use [◀ / ▶] to switch between current subtitle setting and "Off".

- 3) Press [SUBTITLE] repeatedly to exit.



- 1) During playback, press [SUBTITLE].
- 2) Use [▲ / ▼] to select your desired subtitle.

Subtitle 1 English

- Use [◀ / ▶] to switch between current subtitle setting and "Off".

- 3) Press [SUBTITLE] to exit.

Note

- Some discs will only allow you to change the subtitles from the disc menu or pop-up menu. Press [TOP MENU] or [DISC MENU / POP-UP MENU] to display the disc menu or pop-up menu.
- If the disc has no subtitle language or subtitle style, "Not Available" will be displayed on the TV screen.
- During playback of the secondary video, the primary subtitle setting is not available except when there is no subtitle for the secondary video.

Switching Audio Soundtrack

Some BD and DVD contain multiple audio streams. Those are often in different audio languages or audio formats. For BD, available audio varies depending on “Blu-ray Disc Audio” setting. Refer to page 32 for more information.



1) **During playback, press [AUDIO] repeatedly to display “Primary” or “Secondary”.**

“Primary” : Sets the audio for the primary video.

“Secondary” : Sets the audio for the secondary video.

2) **Use [▲ / ▼] to select your desired audio stream channel.**



- For “Secondary”, use [◀ / ▶] to switch between current audio setting and “Off”.

3) **Press [AUDIO] repeatedly to exit.**



1) **During playback, press [AUDIO].**

2) **Use [▲ / ▼] to select your desired audio stream channel.**



3) **Press [AUDIO] to exit.**

Note

- The secondary audio will not be output when the secondary video is not displayed or when “Blu-ray Disc Audio” is set to “Primary Audio Only”. (For some BD, secondary audio will be output even when secondary video is off.)
- The sound mode cannot be changed during playback of discs not recorded in multiple audio.
- Some discs allow changing the audio language setting on the disc menu. (Operation varies depending on the discs. Refer to the manual accompanying the disc.)
- [AUDIO] may not work on some discs with multiple audio streams or channels (e.g. DVDs that allow changing audio setting on the disc menu).
- If the disc has no audio language, “Not Available” will be displayed on the TV screen.
- For DTS-CD (5.1 music disc), selecting audio streams or channels is not available.

Switching Camera Angles



Some BD-video and DVD-video contain scenes which have been shot simultaneously from various angles. You can change the camera angle when appears on the TV screen.

1) **During playback, press [ANGLE].**

- The selected angle will be displayed on the display bar at the top of the TV screen.

2) **Use [▲ / ▼] to select your desired angle.**





Note

- If “Angle Icon” setting is set to “Off”, will not appear on the TV screen. (refer to page 33)

LIST OF SETTINGS







In the settings menu, you can customize the various kinds of settings as you prefer. Refer to the following instruction to navigate through the settings menus.

- 1) Press [HOME ] to access the home menu.
- 2) Use [▲ / ▼] to highlight the “Settings”, then press [OK].
- 3) Use [▲ / ▼] to highlight the “Advanced Setup”, then press [OK].
- 4) Use [▲ / ▼] to move the highlight up and down in the list.
Options of the highlighted item will be displayed in the list on the right whenever available.
- 5) To make a selection or to access options of an item, highlight the desired item, then press [OK].
- 6) Press [HOME ] to exit.

Refer to the following table for the types of settings you can customize.

Settings with (*) can be accessed from the “Quick Setup” also.

The item highlighted in gray is the default setting.

Category	Menus/Options		Description
Advanced Setup	Language	Audio   Default Čeština Norsk Dansk Polski Deutsch Português English Русский Español suomi Ελληνικά Svenska Français Türkçe Italiano Magyar Nederlands	Sets the audio language for BD-video or DVD-video playback. <ul style="list-style-type: none"> If you select “Default”, the disc’s original language will be in effect.
		Subtitle   Off Čeština Norsk Dansk Polski Deutsch Português English Русский Español suomi Ελληνικά Svenska Français Türkçe Italiano Magyar Nederlands	Sets the subtitle language for BD-video or DVD-video playback.
		Disc Menu   Čeština Norsk Dansk Polski Deutsch Português English Русский Español suomi Ελληνικά Svenska Français Türkçe Italiano Magyar Nederlands	Sets the language for disc menu.
		Player Menu* Auto (XXXX) English Español Français	Sets the language for player menu (OSD menu) “Auto”: Activates the Get & Set Menu Language function. (Refer to page 40.) <ul style="list-style-type: none"> “Auto” is available only when “EasyLink (HDMI CEC)” is set to “On”. Inside the parenthesis next to “Auto” will be the current selected language.
	Video Output	TV Shape* • Refer to page 36 for more information.	4:3 Normal 4:3 Crop 16:9 Widescreen 16:9 Squeeze

LIST OF SETTINGS

Category	Menus/Options		Description	
Advanced Setup	Video Output	HDMI 1080p/24  <ul style="list-style-type: none"> This feature is available only when the display device is connected by an HDMI cable. Refer to page 36 for more information. 	Auto Off	"Auto" : Outputs the picture in 1080p/24 (1080 progressive with 24 frames per second) when it meets all the conditions listed below: <ul style="list-style-type: none"> The video resolution and the frame rate of the material is 1080p/24 . "HDMI Video Resolution" setting is set to "1080p". The display device supports the 1080p/24 output. "Off" : <ul style="list-style-type: none"> Outputs the picture in 60p. (60 frames per second, progressive)
		HDMI Video Resolution* <ul style="list-style-type: none"> This feature is available only when the display device is connected by an HDMI cable. Refer to page 36 for more information. 	Auto 480p 720p 1080i 1080p	Sets the resolution of the video signal being output from the HDMI OUT. <ul style="list-style-type: none"> The selected resolution must also be supported by your TV monitor.
		HDMI Deep Color <ul style="list-style-type: none"> This feature is available only when the display device is connected by an HDMI cable, and when it supports Deep Color feature. 	Auto Off	Reduces the posterization effect of the playback picture. "Auto" : Reduces the posterization effect by automatically outputting the 12 bit color whenever the unit recognizes the connected display device supports Deep Color feature. "Off" : Outputs the standard 8 bit color.
	Component Output	480i 480p		Sets the resolution for the component output picture. <ul style="list-style-type: none"> The selected resolution must also be supported by your TV monitor. Refer also to your TV's manual. If you have selected the resolution not supported by your TV by mistake and the picture gets disturbed, press and hold [▶ (PLAY)] on the front panel for 5 seconds to change the setting back to its default. When HDMI cable is connected, only "480i" and the resolution selected in the "HDMI Video Resolution" will be available.
		720p 1080i	With regard to the DVD-Video with a copy protection, the resolution will be set to 480p regardless of the setting here. If 480p output is not available, 480i will be output.	
	De-interlacing Mode	Auto Video		"Auto" : Automatically detects the film or the video content, and appropriately converts it. "Video" : Selects when the picture is distorted when using "Auto".
	Black Level	On Off		Adjust the brightness to compensate for ambient room light.
	Noise Reduction <ul style="list-style-type: none"> Not available for BD-video. 	Off MPEG NR 3D NR Combo (3D + MPEG)		Reduces the noise of the playback picture. "Off" : Deactivates the Noise Reduction. "MPEG NR" : Reduces the block noise seen characteristically in the MPEG files. "3D NR" : Reduces the rough background noise so that you can feel the greater feeling of depth. "Combo (3D + MPEG)" : Activating both "MPEG NR" and "3D NR".

Introduction

Connections





Basic Setup

Playback

Function Setup

Others

LIST OF SETTINGS

Category	Menus/Options		Description
Advanced Setup Audio	Night Mode	On Off	Compresses the range between soft and loud sounds. "On" : Activates the Night Mode. "Off" : Deactivates the Night Mode.
	Down Sampling	On Off	Sets the sampling rate for outputting the PCM audio from the digital output (coaxial/optical). "On" : Over 96 kHz PCM audio will be down sampled at 48 kHz. "Off" : For BD or DVD recorded in LPCM without copyright protection, 2-channel audio signals up to 96 kHz are output as LPCM signals.
	Virtual Surround   	On Off	Select "On" to enjoy the stereophonic virtual space through your existing 2 channel stereo system during playback of BD-video or DVD-video.
	Blu-ray Disc Audio 	Mix Audio Output Primary Audio Only	"Mix Audio Output" : The audio for the secondary video and the interactive application will be output together with the audio for the primary video. "Primary Audio Only" : Only the audio for the primary video will be output. When playing back a BD-video which only contains the primary audio, the audio output will be the same case as the "Primary Audio Only" even if the "Blu-ray Disc Audio" is set to "Mix Audio Output".
	HDMI Audio • This feature is available only when the display device is connected by an HDMI cable. • Refer to page 37 for more information.	HDMI Normal PCM Off	Sets the audio format for the sound output from the HDMI OUT.
	Digital Out • When HDMI cable is connected, make sure "HDMI Audio" setting is set to "Off" to change the "Digital Out" setting. • Refer to page 38 for more information.	Bitstream PCM	Sets the audio format for the sound output from the DIGITAL OUT (OPTICAL/COAXIAL).

LIST OF SETTINGS

Category	Menus/Options		Description	
Ratings Lock • Refer to page 39 for more information.	Rating Level	All 8 [Adult] to 1 [Kid Safe]	Sets the rating level for the disc playback.	
	New PIN		Sets the new password for the "Ratings Lock" setting.	
Others	Angle Icon	On Off	<p>"On" :</p> The angle icon automatically appears on the TV screen when playing back content with various camera angles available. <p>"Off" :</p> The angle icon does not automatically appear on the TV screen when playing back content with various camera angles available.	
	Auto Standby	On Off	Sets whether to turn off the unit (to the standby mode) automatically after 25 minutes of no action since the screen saver is activated. <ul style="list-style-type: none"> If the screen saver is off, the unit will be turned off after 30 minutes if no action. 	
	Front Panel Brightness	Bright Dim Auto	Sets the brightness of the front panel display. When "Auto" is selected, the front panel display automatically goes dim during playback.	
	Screen Saver	On Off	Sets whether to activate the screen saver after 5 minutes of no action on the unit.	
	Slide Show	Slide Show Interval	5sec 10sec	Sets the amount of time for displaying one picture before switching to the next one. For example, select "5sec" to switch the picture every 5 seconds.
		Slide Show Transition	Cut In/Out Fade In/Out	

Advanced Setup

Introduction

Connections

Basic Setup

Playback

Function Setup

Others

LIST OF SETTINGS

Category	Menus/Options		Description			
Advanced Setup	Others	EasyLink (HDMI CEC) • This feature is available only when the display device is connected with an HDMI cable, and when it supports EasyLink (HDMI CEC) feature. • Refer to page 40 for more information.	On Off	Sets whether to utilize the EasyLink (HDMI CEC) function. EasyLink (HDMI CEC) function allows your PHILIPS brand EasyLink TV to act in conjunction with this unit or vice versa.		
		Network Connection	Connection Test		Perform the network connection test. After you change the IP address or DNS setting, always perform this test.	
	Enable(Easy)			If you select "Enable(Easy)", Connection test will automatically start.		
	Enable (Custom)		IP Address Setting	Auto(DHCP)	Set the IP address.	
				Manual	IP Address	In most cases, you can connect to the Internet without making any changes to the default setting.
					Subnet Mask Default Gateway	
	DNS Setting		Auto(DHCP)	Set the DNS setting.		
			Manual	Primary DNS Secondary DNS	In most cases, you can connect to the Internet without making any changes to the default setting.	
	Proxy Setting			Do Not Use	Set the proxy server.	
			Use	Proxy Address Proxy Port	In most cases, you can connect to the Internet without using proxy server.	
	Connection Speed			Auto	Set the connection speed.	
		10BASE Half 10BASE Full 100BASE Half 100BASE Full	In most cases, you can connect to the Internet without making any changes to the default setting.			
	BD-Live Setting	Allow	You can restrict Internet access when BD-Live functions are used.			
		Limited Allow Prohibit				
		Network Status	You can check the current status of the network setting.			
Software Upgrade	Disc Upgrade	Yes	Set the disc upgrade. You can upgrade the firmware version by using the disc. To download the latest firmware version, please visit www.philips.com/support .			
		No				
	Network Upgrade	Yes	Set the network upgrade. You can upgrade the firmware version by connecting this unit to the Internet.			
		No				

LIST OF SETTINGS

Category	Menus/Options		Description
Factory Default	Settings	Yes	"Yes" : Resets all the settings, except for "Ratings Lock" and "Network Connection", in "Settings" to the factory default. "No" : Does not perform the initialization.
		No	
	Format SD Card	Yes	"Yes" : Re-format SD Card. "No" : Does not perform the initialization.
		No	
	Local Storage	Player	Yes
No			
	SD Card	Yes	"Yes" : Re-format local storage (SD Card) used for BD Java. "No" : Does not perform the initialization.
		No	
Network Settings	Yes		"Yes" : Initialize network settings. "No" : Does not perform the initialization.
	No		

Introduction

Connections

Basic Setup

Playback

Function Setup

Others

SETUPS

TV Shape

HOME → "Settings" → "Advanced Setup" → "Video Output" → "TV Shape"

Use this feature to adjust the aspect ratio of the video source which is different from your TV's ratio to fit your TV monitor without distorting the picture. Descriptions of each setting are as follows:

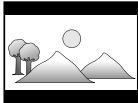
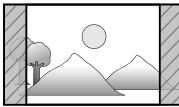
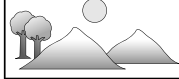
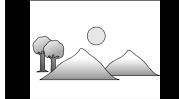
Video source	Your TV	Option	Description
16:9	4:3	4:3 Normal 	To enjoy 16:9 picture on 4:3 monitor: 16:9 picture is scaled down until the both sides of the picture fits the 4:3 TV.
		4:3 Crop 	To enjoy 16:9 picture on 4:3 monitor: Both sides of the picture are trimmed to fit the 4:3 TV without distorting the aspect ratio of the picture.
4:3	16:9	16:9 Widescreen 	To enjoy 16:9 picture on 16:9 monitor: Select this setting when you want to enjoy 16:9 picture on the 16:9 TV.
		16:9 Squeeze 	To enjoy 4:3 picture on 16:9 monitor: Use this setting to display 4:3 picture on the 16:9 TV without distorting the aspect ratio of the picture.

HDMI Video Resolution

HOME → "Settings" → "Advanced Setup" → "Video Output" → "HDMI Video" → "HDMI Video Resolution"

Set the resolution of the video signal being output from the HDMI OUT.

You can select the desired "HDMI Video Resolution" among the settings listed below:

"Auto", "480p", "720p", "1080i", "1080p"

- When you make a selection, the TV monitor temporarily goes blank and then comes back again. If it does not, press **[HDMI]** to change the resolution or press and hold **[▶ (PLAY)]** on the front panel for 5 seconds to change the setting back to its default.

Actual Output Resolution by Media:

Media	BD				
	Source				
Setting in the "HDMI Video Resolution"	480i/60	720p/60	1080i/60	720p/24	1080p/24
480p	480p/60	480p/60	480p/60	480p/60	480p/60
720p	720p/60	720p/60	720p/60	720p/60	720p/60
1080i	1080i/60	1080i/60	1080i/60	1080i/60	1080i/60
1080p	1080p/60	1080p/60	1080p/60	1080p/60	1080p/24 or 60 ^(*)
Auto	The highest resolution supported by your display device will be in effect automatically.				

(*) To output the video in 24 Hz, the connected display device must support 24 Hz output, and "HDMI 1080p/24" should be set to "Auto". Otherwise, the image will be output in 60 Hz.

Media	DVD	Photo viewing	OSD-only viewing
Setting in the "HDMI Video Resolution"	Source		
	480i/60		
480p	480p/60	480p/60	480p/60
720p	720p/60	720p/60	720p/60
1080i	1080i/60	1080i/60	1080i/60
1080p	1080p/60	1080p/60	1080p/60
Auto	The highest resolution supported by your display device will be in effect automatically.		

- When HDMI cable is connected, only "480i" and the resolution selected in the "HDMI Video Resolution" will be available for the "Component Output".
- Composite video out (VIDEO OUT) can only output 480i/60.

Note

- The selected resolution must also be supported by your display device.
- If your TV and the unit is connected by a DVI cable and if you select "Auto", "480p" will be in effect automatically.
- Pressing **[▶ (PLAY)]** on the front panel for 5 seconds changes the setting back to its default. ("Component Output" setting will also be reset to default (480i).)
- Refer also to your TV's manual.

SETUPS

HDMI Audio

HOME → "Settings" → "Advanced Setup" → "Audio" → "HDMI Audio"

Refer to the table below to see which setting you should choose.

	"HDMI Audio" setting →	"HDMI Normal"		"PCM"		"Off"
	"Blu-ray Disc Audio" setting →	"Primary Audio Only"	"Mix Audio Output"	"Primary Audio Only"	"Mix Audio Output"	Regardless
Media ↓	Audio Source ↓	Which audio format can be output depends on the compatibility of the connected device.				
BD-video	Dolby Digital	Dolby Digital or PCM or Mute	Dolby Digital or PCM or Mute	PCM or Mute	PCM or Mute	Mute
	Dolby Digital Plus	Dolby Digital Plus or Dolby Digital or PCM*1 or Mute	Dolby Digital or PCM*1 or Mute	PCM*1 or Mute	PCM*1 or Mute	Mute
	Dolby TrueHD	Dolby TrueHD or Dolby Digital or PCM*2 or Mute	Dolby Digital or PCM*2 or Mute	PCM*2 or Mute	PCM*2 or Mute	Mute
	DTS	DTS or PCM or Mute	DTS or PCM or Mute	PCM or Mute	PCM or Mute	Mute
	DTS-HD	DTS-HD or DTS or PCM*3 or Mute	DTS or PCM*3 or Mute	PCM*3 or Mute	PCM*3 or Mute	Mute
	LPCM	PCM or Mute	PCM or Mute	PCM or Mute	PCM or Mute	Mute
DVD-video	Dolby Digital	Dolby Digital, PCM or Mute		PCM or Mute		Mute
	DTS	DTS, PCM or Mute		PCM or Mute		Mute
	LPCM	2ch PCM or Mute		2ch PCM or Mute		Mute
Audio CD	PCM	2ch PCM or Mute		2ch PCM or Mute		Mute
DTS-CD	DTS	DTS, PCM or Mute		PCM or Mute		Mute

*1) Only the independent substream is decoded.

*2) Only the Dolby Digital substream is decoded.

*3) Only the core substream is decoded.

- When playing back a BD-video which only contains the primary audio, the audio output will be the same case as the "Primary Audio Only" even if the "Blu-ray Disc Audio" is set to "Mix Audio Output".

SETUPS

Digital Out

HOME → "Settings" → "Advanced Setup" → "Audio" → "Digital Out"

Refer to the table below to see which setting you should choose.

	"Digital Out" setting →	"Bitstream"		"PCM"	
	"Blu-ray Disc Audio" setting →	"Primary Audio Only"	"Mix Audio Output"	"Primary Audio Only"	"Mix Audio Output"
Media ↓	Audio Source ↓				
BD-video	Dolby Digital	Dolby Digital	Dolby Digital	DownMix PCM	DownMix PCM
	Dolby Digital Plus* ¹	Dolby Digital	Dolby Digital	DownMix PCM	DownMix PCM
	Dolby TrueHD* ²	Dolby Digital	Dolby Digital	DownMix PCM	DownMix PCM
	DTS	DTS	DTS	DownMix PCM	DownMix PCM
	DTS-HD* ³	DTS	DTS	DownMix PCM	DownMix PCM
	LPCM	DownMix PCM	DownMix PCM	DownMix PCM	DownMix PCM
DVD-video	Dolby Digital	Dolby Digital		DownMix PCM	
	DTS	DTS		DownMix PCM	
	LPCM	2ch PCM		2ch PCM	
Audio CD	PCM	2ch PCM		2ch PCM	
DTS-CD	DTS	DTS		DownMix PCM	

*1) Only the independent substream is decoded.

*2) Only the Dolby Digital substream is decoded.

*3) Only the core substream is decoded.

- When playing back a BD-video which only contains the primary audio, the audio output will be the same case as the "Primary Audio Only" even if the "Blu-ray Disc Audio" is set to "Mix Audio Output".

Ratings Lock

HOME → "Settings" → "Advanced Setup" → "Ratings Lock"

Some BD-video or DVD-video feature a ratings lock level. Playback will stop if the ratings exceed the levels you set, it will require you to enter a password before the disc will playback. This feature prevents your children from viewing inappropriate material.

1) With "Ratings Lock" selected in the "Advanced Setup" menu, press [OK].

Language	Rating Level
Video Output	New PIN
Audio	
Ratings Lock	
Others	

2) If a PIN code has not been set, proceed to step 2-a). If a PIN code has already been set, proceed to step 2-b).

If you want to change the PIN code, proceed to step 2-c).

If you forget the PIN code, proceed to step 2-d).

2-a) Enter 4 digit PIN code using [the Number buttons].

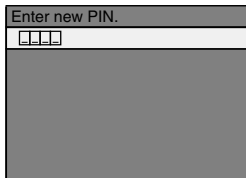

- "4737" cannot be used.
- Press [RED] to return to the previous screen.

2-b) Enter 4 digit PIN code using [the Number buttons].

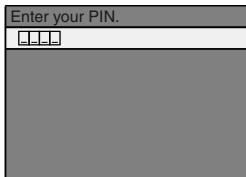

2-c) Follow step 2-b). Select "New PIN", then press [OK]. Enter the new PIN code.

2-d) Enter "4737". Current PIN code and the "Ratings Lock" settings are now cleared. Follow step 1) and step 2-a) to create a new PIN code.

3) After entering the PIN code, "Rating Level" appears. (If not, use [▲ / ▼] to highlight "Rating Level".) Select desired rating level then press [OK].

Rating Level	All
New PIN	8 [Adult]
	7
	6
	5
	4
	3
	2

	RATING EXPLANATIONS
All	• Ratings Lock Control is inactive; all discs can playback.
8 [Adult]	• DVD software of any grades (adult/general/children) can be played back.
7	• [NC-17] No one under 17 admitted.
6	• [R] Restricted; under 17 requires accompanying parent or adult guardian.
5	• [PGR] Parental Guidance Recommended.
4	• [PG13] Unsuitable for children under 13.
3	• [PG] Parental Guidance suggested.
2	• [G] General Audience.
1 [Kid Safe]	• Suitable for children.

To cancel ratings lock temporarily

Some discs allow you to cancel the ratings lock temporarily. With those discs, the message below will appear when you try to play them back.

"Please enter your PIN to unblock content."

Follow the instruction which appears on the screen to cancel the ratings lock. After entering the PIN code, "Rating Level" appears.

Select desired rating level, then press [OK].

SETUPS

EasyLink (HDMI CEC)

HOME → "Settings" → "Advanced Setup" → "Others" → "EasyLink (HDMI CEC)"

EasyLink (HDMI CEC) function allows your TV (limited to PHILIPS brand EasyLink TV) to act in conjunction with this unit, or vice versa.

When "EasyLink (HDMI CEC)" setting is set to "On", functions listed below will be available.

One Touch Play

When this unit is turned on, the TV also is turned on and the appropriate external input channel will be selected automatically. The appropriate external input channel can also be selected on your TV automatically when you press [PLAY ▶], [PREV ◀], [NEXT ▶], [the Number buttons], [HOME ⬆], [INFO ⓘ], [TOP MENU], or [DISC MENU / POP-UP MENU] when the unit's power is on.

Standby

When you press and hold [STANDBY-ON ⏻] for 2 seconds, it turns off the power of the TV first and then turns off the power of this unit also.

System Information

Get & Set Menu Language

The unit recognizes the OSD language set for the TV and automatically sets the same language as the player menu language (OSD menu language) for this unit. Refer to the "Player Menu" on page 30 for available languages.

- This feature is available only when "Auto" is selected in the "Player Menu" in the settings menu.

Network Connection

Set up the network connection settings in order to use the BD-Live function with a BD-Live disc.

Connection Test

HOME → "Settings" → "Advanced Setup" → "Others" → "Network Connection" → "Connection Test"

After you made IP address/DNS settings or when a LAN cable is connected, always perform the connection test to check if the connection is correctly made.

- 1) Use [▲ / ▼] to highlight "Settings" in the home menu, then press [OK].
- 2) Use [▲ / ▼] to highlight "Advanced Setup", then press [OK].
- 3) Use [▲ / ▼] to highlight "Others", then press [OK].
- 4) Use [▲ / ▼] to highlight "Network Connection", then press [OK].
- 5) Use [▲ / ▼] to highlight "Connection Test", then press [OK].

Connection test will start automatically and the test result will appear right after the connection test finishes.

- "Testing..": The test is in progress.
- "Pass": Connection test is successfully completed.
- "Fail": Connection test failed. Check the connection settings.

Press [OK] to go to the list of network status confirmation screen.

IP Address	*** ** *
Subnet Mask	*** ** *
Default Gateway	*** ** *
Primary DNS	*** ** *
Secondary DNS	*** ** *
	then press 'OK'.

- 6) Press [OK] to go back to the previous screen, or press [HOME ⬆] to go back to the home menu.

Note

- If the connection test passes, you can enjoy the BD-Live functions using the Internet without making any extra settings.
- If the connection test fails, you may need to change the MAC address settings of your router. You can check the MAC address of this unit on "Network Status" screen. (refer to page 43).

Enable(Easy)

HOME → "Settings" → "Advanced Setup" → "Others" → "Network Connection" → "Enable (Easy)"

Network settings are set to the following settings initially. (In most cases, you can connect to the Internet without making any changes to the default settings.)

- IP Address Setting Auto(DHCP)
- DNS Setting Auto(DHCP)
- Proxy Setting Do Not Use
- Connection Speed Auto
- BD-Live Setting Allow

If you want to set the network settings back to the default settings as above (except "BD-Live Setting"), follow the procedure below.

- 1) Follow steps 1) to 4) in "Connection Test" on page 40.
- 2) Use [▲ / ▼] to highlight "Enable(Easy)", then press [OK].
 - The unit will start the connection test automatically and the test result will appear right after the test finishes.
 - After the connection test finishes, press [OK] to go to network status confirmation screen.
- 3) Press [OK] to activate the network settings and set the network connection automatically. [HOME ▲] to go back to the home menu.

Note

- The setting of "BD-Live Setting" will not be set back to the default, even if you follow the procedure.

Enable(Custom)

HOME → "Settings" → "Advanced Setup" → "Others" → "Network Connection" → "Enable (Custom)"

In following cases, select "Enable(Custom)" to set each setting as necessary.

- When connection test failed with the setting of "Enable(Easy)".
- When instructed by your Internet service provider to make specific settings in accordance with your network environment.

• IP Address Setting / DNS Setting

- 1) Follow steps 1) to 4) in "Connection Test" on page 40.
- 2) Use [▲ / ▼] to highlight "Enable(Custom)", then press [OK].
- 3) Use [▲ / ▼] to highlight "IP Address Setting", then press [OK].
- 4) Use [▲ / ▼] to highlight the desired setting, then press [OK].

"Auto(DHCP)"	: If your router has DHCP server function, select "Auto(DHCP)".
"Manual"	: If your router does not have DHCP server function, select "Manual".

If you select "Manual", follow the following instruction to set the IP address and DNS.

- 4-a) IP address setting screen will appear. Enter IP address, subnet mask and default gateway with cursor buttons and number buttons.

- Enter the IP address number after checking the specifications of your router.
- If the IP address number is unknown, check the IP address number of other devices. (e.g. PC connected via LAN cable) and assign a different number from those of other devices.

After you enter all correctly, press [OK] to go to the DNS setting screen.

- 4-b) DNS setting screen will appear. Enter primary DNS and secondary DNS with cursor buttons and number buttons.

- Enter the numbers instructed by your Internet provider.
- If the number is unknown, check the number of other devices (e.g. PC connected via LAN cable) and assign the same number.

- 4-c) After you enter all correctly, press [OK].
 - Confirmation message will appear. Select "Yes" to complete the settings.

IP Address	*** ** *
Subnet Mask	*** ** *
Default Gateway	*** ** *
Primary DNS	*** ** *
Secondary DNS	*** ** *
	Is Setting OK?
	Yes
	No

- 5) Press [BACK ↶] to go back to the previous screen, or press [HOME ▲] to go back to the home menu.

SETUPS

Note

- The range of input number is between 0 and 255.
- If you enter a number larger than 255, the number will automatically be 255.
- The manually entered number will be saved even if you change the setting to "Auto(DHCP)".
- When you enter a wrong number, press **[RED]** to cancel. (the number will be back to "0".)
- If you want to enter 1 or 2 digit number in one cell, press **[▶]** to move on to the next cell.
- If the entered IP address or the default gateway or primary DNS number is same as the default setting, IP address setting will be set to "Auto(DHCP)". (The manually entered number will be saved).
- When IP address setting is set to "Manual", the setting of DNS setting will automatically be "Manual" and when IP address setting is set to "Auto(DHCP)", you can set either "Auto(DHCP)" or "Manual" for DNS setting.

• Proxy Setting

- 1) Follow steps 1) to 4) in "Connection Test" on page 40.
- 2) Use **[▲ / ▼]** to highlight "Enable(Custom)", then press **[OK]**.
- 3) Use **[▲ / ▼]** to highlight "Proxy Setting", then press **[OK]**.
- 4) Use **[▲ / ▼]** to highlight the desired setting, then press **[OK]**.
 - For default settings, select "Do Not Use".
 - If you need to change the proxy setting as instructed by your Internet service provider to set the designated proxy address and port, select "Use".

If you select "Use", follow the following instructions to set the proxy address and proxy port.

- 4-a) Proxy address setting screen will appear. Enter proxy address.
 - The keyboard screen will appear.

△ Proxy Setting
Proxy Address

1	2	3	4	5	6	7	8	9	0
a	b	c	d	e	f	g	h	i	j
k	l	m	n	o	p	q	r	s	t
u	v	w	x	y	z	.	-	-	OK

● Clear ● All Clear ● a/A/@ ○ OK

[▲ / ▼ / ◀ / ▶] : Move the highlight.

[the Number buttons] : Enter number.

[OK] : Enter the highlighted number/word.

***[RED]** : Clear the entered number or word.

[GREEN] : Clear all the entered numbers or words.

[BLUE] : Switch between abc ? ABC ? @!?

***[YELLOW]** : Set the entered number or word.

* These buttons can be used in other network settings.

After you enter all correctly, press [YELLOW] to go to the proxy port setting screen.

- 4-b) Proxy port setting screen will appear. Enter proxy port number with number buttons.

△ Proxy Setting
Proxy Port
0

● Clear ● ● ○ OK

- 4-c) After you enter all correctly, Press **[YELLOW]**.
 - Confirmation message will appear. Select "Yes" to complete the settings.

Proxy Address	*****
Proxy Port	****
	Is Setting OK?
	Yes
	No

- 5) Press **[BACK ↵]** to go back to the previous screen, or press **[HOME ⬆]** to go back to the home menu.

Note

- The range of input number for the port number is between 0 and 65535. (If you enter a number larger than 65535, it will be regarded as 65535.)
- For proxy port, the selected ports may be blocked and not be able to use depending on your network environment.
- If the proxy address is entered with blank only, proxy server setting will be set to "Do Not Use".

• **Connection Speed**

You can set connection speed as your preference. (The default setting is "Auto".)

- 1) Follow steps 1) to 4) in "Connection Test" on page 40.
- 2) Use [▲ / ▼] to highlight "Enable(Custom)", then press [OK].
- 3) Use [▲ / ▼] to highlight "Connection Speed", then press [OK].
- 4) Use [▲ / ▼] to highlight the desired setting, then press [OK].

"Auto":

Set the appropriate connection speed automatically, in accordance with your network environment.

"10BASE Half":

Set the connection speed to "10BASE Half".

"10BASE Full":

Set the connection speed to "10BASE Full".

"100BASE Half":

Set the connection speed to "100BASE Half".

"100BASE Full":

Set the connection speed to "100BASE Full".

- 5) Press [BACK ↵] to go back to the previous screen, or press [HOME ⬆] to go back to the home menu.

Note

- Choose a connection speed in accordance with your network environment.
- The network connection may be disabled depending on the device, when the settings are changed.

• **BD-Live Setting**

You can limit the Internet access from the BD-Live functions. (The default setting is "Allow".)

- 1) Follow steps 1) to 4) in "Connection Test" on page 40.
- 2) Use [▲ / ▼] to highlight "Enable(Custom)", then press [OK].
- 3) Use [▲ / ▼] to highlight "BD-Live Setting", then press [OK].
- 4) Use [▲ / ▼] to highlight the desired setting, then press [OK].

"Allow":

Internet access is permitted from all BD-Live contents.

"Limited Allow":

Internet access is permitted only for BD-Live contents which have content owner certificates. Internet access without the certificates are prohibited.

"Prohibit":

Internet access is prohibited from all BD-Live contents.

- 5) Press [BACK ↵] to go back to the previous screen, or press [HOME ⬆] to go back to the home menu.

• **Network Status**

You can check the status of network settings.

- 1) Follow steps 1) to 4) in "Connection Test" on page 40.
- 2) Use [▲ / ▼] to highlight "Enable(Custom)", then press [OK].
- 3) Use [▲ / ▼] to highlight "Network Status", then press [OK].
 - Network setting list will be displayed.
- 4) Press [BACK ↵] to go back to the previous screen, or press [HOME ⬆] to go back to the home menu.

Disable

HOME → "Settings" → "Advanced Setup" → "Others" → "Network Connection" → "Disable"

Deactivate all the network connection and settings.

- 1) Follow steps 1) to 4) in "Connection Test" on page 40.
- 2) Use [▲ / ▼] to highlight "Disable", then press [OK].
- 3) Use [▲ / ▼] to highlight "Yes", then press [OK].
- 4) Press [BACK ↵] to go back to the previous screen, or press [HOME ⬆] to go back to the home menu.

Note

- The network connection can be reactivated by setting the network connection to "Enable(Easy)" or "Enable(Custom)".

Software Upgrade

Disc Upgrade

HOME → "Settings" → "Advanced Setup" → "Others" → "Software Upgrade" → "Disc Upgrade"

You can upgrade the software by using disc.

- 1) Follow steps 1) to 3) in "Connection Test" on page 40.
- 2) Use [▲ / ▼] to highlight "Software Upgrade", then press [OK].
- 3) Use [▲ / ▼] to highlight "Disc Upgrade", then press [OK].
- 4) Use [▲ / ▼] to highlight "Yes", then press [OK].
- 5) Disc tray will open automatically.
 - Insert the disc for software upgrade and then press [OPEN/CLOSE ▲].
- 6) After completing loading disc, confirmation message will appear. Use [◀ / ▶] to highlight "Yes" and press [OK] to start upgrading.
 - It may take a while to complete the upgrading.
- 7) After the disc upgrade finishes, this unit will restart and open the disc tray automatically. Remove the disc.

Note

- Please visit www.philips.com/support to download the latest firmware version.
- Please do not unplug the AC power cord while executing the "Disc Upgrade".
- All settings will remain the same even if you upgrade the firmware version.

Network Upgrade

HOME → "Settings" → "Advanced Setup" → "Others" → "Software Upgrade" → "Network Upgrade"

You can upgrade the software by connecting the unit to the Internet.

- 1) Follow steps 1) to 3) in "Connection Test" on page 40.
- 2) Use [▲ / ▼] to highlight "Software Upgrade", then press [OK].
- 3) Use [▲ / ▼] to highlight "Network Upgrade", then press [OK].
- 4) Use [▲ / ▼] to highlight "Yes", then press [OK].
 - This unit will then start checking for the latest firmware version.
- 5) Confirmation message will appear. Use [◀ / ▶] to highlight "Yes", then press [OK].
 - The unit will start downloading the latest firmware version.
- 6) When the download completes, confirmation message will appear. Press [OK].
 - The unit will start upgrading the firmware version.
 - It may take a while to complete the upgrading.
- 7) After upgrading finishes, this unit will restart and open the disc tray automatically.

Note

- Please do not unplug the AC power cord or LAN cable while executing the "Network Upgrade".
- All settings will remain the same even if you upgrade the software version.
- The disc tray will open automatically after upgrading finishes. This is not a malfunction.

Reset to Factory Default

Initialize the setting, SD Memory Card or network setting.

- 1) Use [▲ / ▼] to highlight "Settings" in the home menu, then press [OK].
- 2) Use [▲ / ▼] to highlight "Factory Default", then press [OK].
- 3) Use [▲ / ▼] to highlight the desired setting, then press [OK].
 - "Settings":**
All the settings except for the "Ratings Lock" and "Network Connection" setting will be reset to default.
 - "Format SD Card" (Available only when an SD Memory Card is inserted):**
Initialize the SD Memory Card.
 - "Local Storage":**
Local storage for Player or SD Card (Available only when an SD Memory Card is inserted) used for BD-Java will be initialized.
 - "Network Settings":**
Reset the network setting to the default.
- 4) Use [▲ / ▼] to highlight "Yes", then press [OK].
 - Confirmation message will appear. Press [OK] to complete the setting.
- 5) Press [BACK ↵] to go back to the previous screen, or press [HOME ⬅] to go back to the home menu.

Note

- Do not remove the SD Memory Card while executing the "Format SD Card" or "Local Storage" (SD Card). It will damage the card.
- "Format SD Card" and "Local Storage" (SD Card) are not available when a Blu-ray Disc is in the unit.

TROUBLESHOOTING

	Problem	Tip
POWER	No reaction to the remote control.	Connect the product to the power outlet. Point the remote control at the product. Insert the batteries correctly. Insert new batteries in the remote control.
	No video signal on the display device.	Turn on the TV. Set the TV to the correct external input. Select the correct video resolution using [HDMI] . Press and hold [▶ (PLAY)] on the front panel for 5 seconds to change the setting back to its default.
	No audio / video signal on the display device via HDMI cable.	If the unit is connected to the unauthorized display device with an HDMI cable, the audio/video signal may not be output.
	No high-definition video signal on the TV.	Does the disc contain high-definition video? High-definition video is not available when the disc does not contain it. Does the TV support high-definition video? High-definition video is not available when the TV does not support it.
	No audio signal from the loudspeakers of the TV.	Assign the audio input of the TV to the corresponding video input.
	No audio signal from the loudspeakers of the audio system.	Turn on the audio system. Set the audio system to the correct external input. Increase the volume level of the audio system.
GENERAL	Cannot play back a disc.	Make sure that the product supports the disc. Make sure that the Blu-ray Disc player supports the region code of the DVD or BD. (BD: A: DVD: All or 1) For DVD-RW/-R, make sure that the disc is finalized. Clean the disc.
	SD Memory Card cannot be read.	The format of the card does not match that accepted by this unit or the card is not compatible.
	Cannot play back JPEG files from a disc.	Make sure that the disc was recorded in the UDF, ISO9660 or JOLIET format.
	 in the upper right hand corner of the screen.	The operation is not possible.
	Cannot find a JPEG file.	Make sure that the selected group (folder) does not contain more than 9,999 files for DVD, and 999 files for CD. Make sure that the file extension is .jpg, .JPG, .jpeg or .JPEG.
	Error message appears when I select "Auto" in the "Player Menu".	Make sure that the unit is connected to the PHILIPS brand EasyLink TV and the "EasyLink (HDMI CEC)" is set to "On" This error message may appear when your TV's OSD language is not supported by this unit.
	Cannot connect to the network.	Check if the LAN cable connection is properly made. Turn on the modem or broadband router. Check the network settings. Check if the broadband router and/or modem is correctly connected. Check the "BD-Live Setting".
	Cannot connect to the network while my PC is connected to the network.	Check the content of your Internet service contract to see if your Internet Service Provider prevents multiple terminals connecting at the same time.
	The capacity of the SD Card decreased.	The data may be written to the SD card when a BD-video that supports the virtual package is used and an SD card is in the slot.
	MPEG-2 video and audio on the SD card cannot be played back.	MPEG-2 is noncompliant on this unit.
	The contents of the card cannot be read.	The card is not compatible or the contents on the card may be damaged. Turn off and then turn the unit on again.
	Cannot use the BD-Live function or download of data does not perform properly.	Insert an SD card with enough space(1GB or more). Check if an SD card is correctly inserted.
	Cannot play back BD-video(BD-ROM Profile 2.0).	Insert an SD card(1GB or more) which is formatted on this unit. Some discs with BD-Live function require memory when playing back the content. Do not remove the card during playback.

GLOSSARY

Analog Audio

An electrical signal that directly represents sound. Compare this to digital audio which can be an electrical signal, but is an indirect representation of sound. See also "Digital Audio".

Aspect Ratio

The width of a TV screen relative to its height. Conventional TVs are 4:3 (in other words, the TV screen is almost square); widescreen models are 16:9 (the TV screen is almost twice as wide as it is high).

BD-Live

BD-Live is a BD-video (BD-ROM version 2 Profile 2.0) which contains new functions (e.g. Internet connection), in addition to the BONUSVIEW function.

Blu-ray Disc (BD)

Blu-ray Disc is a next generation optical video disc which is capable of storing much more data than a conventional DVD. The large capacity makes it possible to benefit from the features such as high-definition videos, multi-channel surround sounds, interactive menus and so on.

Chapter

Just as a book is split up into several chapters, a title on a BD-video or DVD-video is usually divided into chapters. See also "Title".

Component Video Output

Each signal of luminance (Y) and component (P_B/C_B, P_R/C_R) is independent to output so that you can experience picture color as it is.

Also, due to compatibility with progressive video (525p/480p), you can experience higher-density picture than that in interlace (525i/480i).

Digital Audio

An indirect representation of sound by numbers. During recording, the sound is measured at discrete intervals (44,100 times a second for CD audio) by an analog-to-digital converter, generating a stream of numbers. On playback, a digital-to-analog converter generates an analog signal based on these numbers. See also "Sampling Frequency" and "Analog Audio".

DNS Server

A server which translates Internet domain names into IP addresses.

Dolby Digital

The system to compress digital sound developed by Dolby Laboratories. It offers you sound of stereo (2ch) or multi-channel audio.

Dolby Digital Plus

Dolby Digital Plus is the next generation digital audio compression technology developed as an extension to Dolby Digital. Blu-ray Disc supports 7.1 multi-channel surround sound output.

Dolby TrueHD

Dolby TrueHD is a lossless coding technology developed for next generation optical discs. Blu-ray Disc supports 7.1 multi-channel surround sound output.

DTS (Digital Theater System)

DTS is a multi channel surround sound system. You can enjoy movie dynamic and realistic sound like movie theater. DTS surround sound technologies were developed by DTS, Inc.

DTS-HD

DTS-HD is a lossless coding technology developed as an extension of the original DTS Coherent Acoustics format. Blu-ray Disc supports 7.1 multi-channel surround sound output.

Gateway

IP address of the electronic devices (such as router) which provide Internet access.

HDMI (High Definition Multimedia Interface)

A digital interface between audio and video source. It can transmit component video, audio, and control signal with one cable connection.

Hub

A device used for connecting multiple device to the network.

IP Address

A set of numbers which are assigned to devices participating in a computer network.

JPEG (Joint Photographic Experts Group)

JPEG is a method of compressing still picture files. You can copy JPEG files on CD-RW/-R, DVD or SD Memory Card from a computer and play back the files on this unit.

GLOSSARY

LAN (Local Area Network)

A group of computer networks covering a small area like a company, school or home.

Local Storage

A storage area of sub contents for playing virtual packages on BD-video.

PCM (Pulse Code Modulation)

The most common system of encoding digital audio, found on CD and DAT. Excellent quality, but requires a lot of data compared to formats such as Dolby Digital and MPEG audio. For compatibility with digital audio recorders (CD, MD and DAT) and AV amplifiers with digital inputs, this unit can convert Dolby Digital and MPEG audio to PCM. See also "Digital Audio".

Proxy Server

Proxy server is a server which acts as an intermediary between a workstation user and the Internet to ensure security.

Region Code

Regions associate discs and players with particular areas of the world. This unit will only play back discs that have compatible region codes. You can find the region code of your unit by looking on the rear panel. Some discs are compatible with more than one region (or all regions).

Router

A networking device which distinguishes the IP address assigned to each device and routing and forwarding information in the computer network.

Sampling Frequency

The rate which sound is measured by a specified interval to turn into digital audio data. The numbers of sampling in one second defines as sampling frequency. The higher the rate, the better the sound quality.

Subnet Mask

A mask which is used to determine what subnet an IP address belongs to.

Title

A collection of chapters on BD-video or DVD-video. See also "Chapter".

Track

Audio CD use tracks to divide up the content of a disc. The BD-video or DVD-video equivalent is called a chapter. See also "Chapter".

Virtual Package

The function which copies data to other media (local storage) from the Internet and play the secondary video, secondary audio and the subtitle at the same time. The method of the playback varies depending on discs.

SPECIFICATIONS

General

Signal System	NTSC Color
Power requirements	120 V AC, 60 Hz
Power consumption	22 W (standby: 0.7 W)
Dimensions (width x height x depth)	17.2 x 2.5 x 11.9 inches (435 x 65 x 303 mm)
Weight	6.8 lbs. (3.1 kg)
Operating temperature	41°F (5°C) to 104°F (40°C)
Operating humidity	Less than 80 % (no condensation)

Terminals

Front	SD Card slot			
	slot x 1			
Rear	Audio output (Analog)			
	RCA jack x 2	L/R: 2 Vrms (output impedance: more than 1kΩ)		
	Video output			
	RCA jack x 1	1 Vp-p (75Ω)		
	Component video output			
	RCA jack x 3	Y: 1 Vp-p (75Ω)	P _B /C _B : 700 mVp-p (75Ω)	P _R /C _R : 700 mVp-p (75Ω)
	Audio output (Digital)			
	RCA jack x 1 Optical jack x 1	500 mVp-p (75Ω) Digital connector		
HDMI output				
HDMI jack x 1	Video: 480p, 720p, 1080i, 1080p/Audio			
LAN Terminal	10BASE-T / 100BASE-TX			

Note

- The specifications and design of this product are subject to change without notice.

ONE (1) YEAR LIMITED WARRANTY

WARRANTY COVERAGE:

This warranty obligation is limited to the terms set forth below.

WHO IS COVERED:

This product is warranted to the original purchaser or the person receiving the product as a gift against defects in materials and workmanship as based on the date of original purchase ("Warranty Period") from an Authorized Dealer. The original sales receipt showing the product name and the purchase date from an authorized retailer is considered such proof.

WHAT IS COVERED:

This warranty covers new products if a defect in material or workmanship occurs and a valid claim is received within the Warranty Period. At its option, the company will either (1) repair the product at no charge, using new or refurbished replacement parts, or (2) exchange the product with a product that is new or which has been manufactured from new, or serviceable used parts and is at least functionally equivalent or most comparable to the original product in current inventory, or (3) refund the original purchase price of the product. The Company warrants replacement products or parts provided under this warranty against defects in materials and workmanship from the date of the replacement or repair for ninety (90) days or for the remaining portion of the original product's warranty, whichever provides longer coverage for you. When a product or part is exchanged, any replacement item becomes your property and the replaced item becomes the company's property. When a refund is given, your product becomes the company's property. **Note: Any product sold and identified as refurbished or renewed carries a ninety (90) day limited warranty.**

Replacement product can only be sent if all warranty requirements are met. Failure to follow all requirements can result in delay.

WHAT IS NOT COVERED - EXCLUSIONS AND LIMITATIONS:

This Limited Warranty applies only to the new products that can be identified by the trademark, trade name, or logo affixed to it. This Limited Warranty does not apply to any non-Philips hardware product or any software, even if packaged or sold with the product. Non-Philips manufacturers, suppliers, or publishers may provide a separate warranty for their own products packaged with the bundled product.

The Company is not liable for any damage to or loss of any programs, data, or other information stored on any media contained within the product, or any non-Philips product or part not covered by this warranty. Recovery or reinstallation of programs, data or other information is not covered under this Limited Warranty.

This warranty does not apply (a) to damage caused by accident, abuse, misuse, neglect, misapplication, or non-Philips product, (b) to damage caused by service performed by anyone other than an Authorized Service Location, (c) to a product or

a part that has been modified without written permission, or (d) if any serial number has been removed or defaced, or (e) product, accessories or consumables sold "AS IS" without warranty of any kind by including refurbished Philips product sold "AS IS" by some retailers.

This Limited Warranty does not cover:

- Shipping charges to return defective product.
- Labor charges for installation or setup of the product, adjustment of customer controls on the product, and installation or repair of antenna/signal source systems outside of the product.
- Product repair and/or part replacement because of improper installation or maintenance, connections to improper voltage supply, power line surge, lightning damage, retained images or screen markings resulting from viewing fixed stationary content for extended periods, product cosmetic appearance items due to normal wear and tear, unauthorized repair or other cause not within the control of the company.
- Damage or claims for products not being available for use, or for lost data or lost software.
- Damage from mishandled shipments or transit accidents when returning product.
- A product that requires modification or adaptation to enable it to operate in any country other than the country for which it was designed, manufactured, approved and/or authorized, or repair of products damaged by these modifications.
- A product used for commercial or institutional purposes (including but not limited to rental purposes).
- Product lost in shipment and no signature verification receipt can be provided.
- Failure to operate per Owner's Manual.

TO OBTAIN ASSISTANCE IN THE U.S.A., CANADA, PUERTO RICO, OR U.S. VIRGIN ISLANDS...

Contact Customer Care Center at:
1-866-309-0866

REPAIR OR REPLACEMENT AS PROVIDED UNDER THIS WARRANTY IS THE EXCLUSIVE REMEDY FOR THE CONSUMER. PHILIPS SHALL NOT BE LIABLE FOR ANY INCIDENTAL OR CONSEQUENTIAL DAMAGES FOR BREACH OF ANY EXPRESS OR IMPLIED WARRANTY ON THIS PRODUCT. EXCEPT TO THE EXTENT PROHIBITED BY APPLICABLE LAW, ANY IMPLIED WARRANTY OF MERCHANTABILITY OR FITNESS FOR A PARTICULAR PURPOSE ON THIS PRODUCT IS LIMITED IN DURATION TO THE DURATION OF THIS WARRANTY.

Some states do not allow the exclusions or limitation of incidental or consequential damages, or allow limitations on how long an implied warranty lasts, so the above limitations or exclusions may not apply to you.

This warranty gives you specific legal rights. You may have other rights which vary from state/province to state/province.

P&F USA, Inc.
PO Box 430 Daleville, IN 47334-0430

Introduction

Connections

Basic Setup

Playback

Function Setup

Others

MEMO

MEMO

Introduction

Connections

Basic Setup

Playback

Function Setup

Others

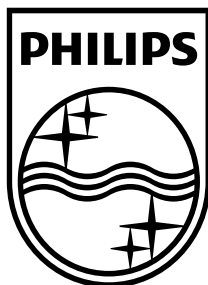

P&F USA, Inc.
PO Box 430 Daleville, IN 47334-0430

Meet Philips at the Internet
<http://www.philips.com/welcome>

